

The Journal of The Royal Astronomical Society of Canada

# Journal

Le Journal de la Société royale d'astronomie du Canada

PROMOTING  
ASTRONOMY  
IN CANADA

June/juin 2014

Volume/volume 108

Number/numéro 3 [766]

**Inside this issue:**

Early Extragalactic  
Astrophysics

Great Observatories

Telescopes in Miniature

Planet Crossword

*A Starscape in  
Red and Blue*



## The Best of Monochrome.

Drawings, images in black and white, or narrow-band photography.



*Right place, right time, right camera, and right telescope. It wasn't accidental that the Winnipeg Centre's Sheila Wiwchar was able to capture the International Space Station from a vantage point north of Winnipeg as it passed over the waxing Moon on April 9.*

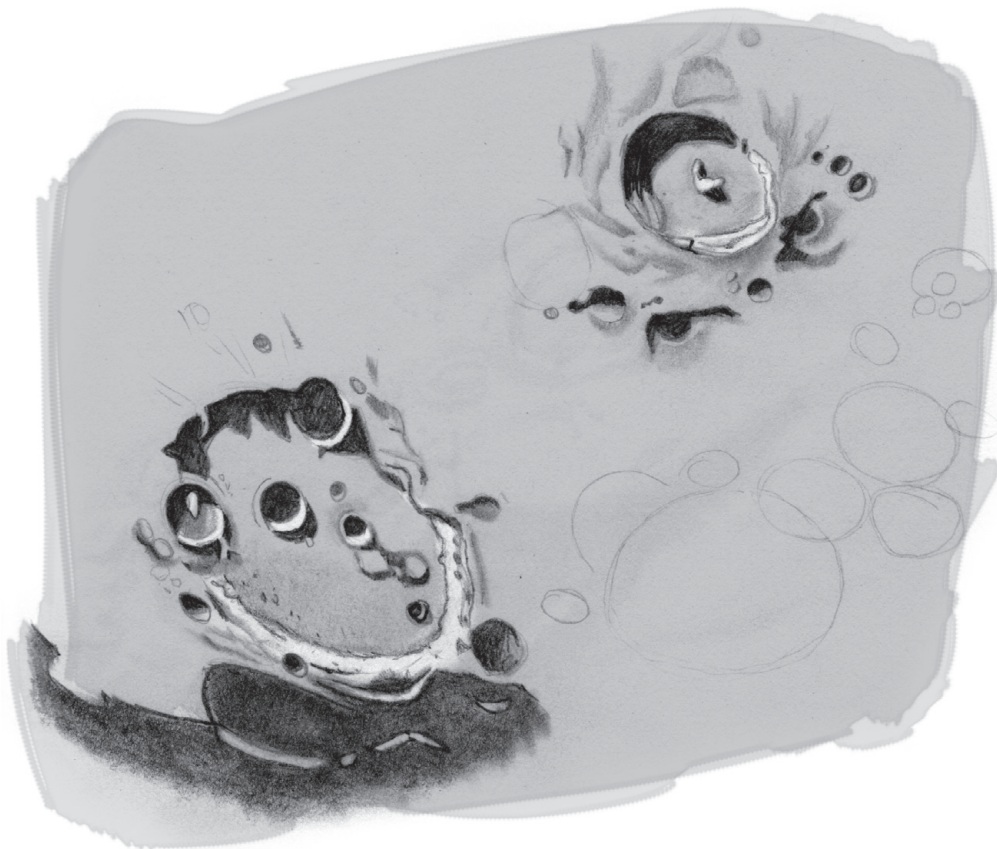

*Michael Gatto of the Halifax Centre captured this view of craters Tycho (top) and Clavius (bottom left) from his home in Dartmouth, Nova Scotia on March 10. This sketch was made under excellent seeing conditions at the eyepiece of a 4" f/10 achromat at 125 $\times$ , with dark and light tones added in Photoshop.*



## contents / table des matières

### Feature Articles / Articles de fond

- 99 **Solar-Motion Correction in Early Extragalactic Astrophysics**  
*by Domingos Soares and Luiz Paulo R. Vaz*
- 104 **Great Observatories**  
*by Klaus Brasch*
- 111 **An Evening With Neil deGrasse Tyson**  
*by Nicole Mortillaro*
- 112 **Telescopes in Miniature**  
*by Barry Matthews with R.A. Rosenfeld*
- 129 **Planet Crossword**  
*by Naomi Pasachoff*
- 139 **Answers to April's Galaxy Crossword**  
*by Naomi Pasachoff*

### Columns / Rubriques

- 116 **Pen and Pixel: Christmas Tree Nebula / M106 / Milky Way Rising / Eagle Nebula**  
*Klaus Brasch / Rodney Dingman / John D. McDonald / Stephen Holmes*
- 120 **Cosmic Contemplations: Build Your Own Thermal-Electrically Cooled True Monochrome DSLR For Less Than \$300!**  
*by Jim Chung*
- 123 **Rising Stars: Thanks to the Unknown Soldiers of Astronomy**  
*by John Crossen*
- 124 **Second Light: Rings Around An Asteroid**  
*by Leslie J. Sage*
- 126 **Imager's Corner: Starless Masks**  
*by Blair MacDonald*
- 130 **Fun With Arduinos—Part 2: An Arduino-Based Focus Controller**  
*by Rick Saunders*
- 132 **John Percy's Universe: Outreach!**  
*by John R. Percy*
- 134 **Through My Eyepiece: Spring has Sprung**  
*by Geoff Gaherty*

### Departments / Départements

- 94 **News Notes/En manchettes**  
*Compiled by Andrew I. Oakes*
- *Analysis of Martian sediment adds to habitability speculation*
  - *First-light images better by almost a factor of 10*
  - *Three-body system includes fast-spinning pulsar*
  - *Jade Rabbit leaves fresh tracks on Moon*
  - *Top astronomers mentor university students*
- 134 **Reviews/Critiques**  
*Discovery and Classification in Astronomy: Controversy and Consensus*  
*A Student's Guide to the Mathematics of Astronomy*  
*Fundamental Planetary Science: Physics, Chemistry and Habitability*  
*Astrobiology: A Very Short Introduction*
- 139 **Society News**  
*by James Edgar*
- 140 **Astrocryptic and April Answers**  
*by Curt Nason*
- 140 **It's Not All Sirius**  
*by Ted Dunphy*

Front Cover — With summer come the starscapes of Sagittarius to provide observers and photographers with a swarm of Milky Way treats. Among the most attractive of the offerings are the Lagoon and Trifid Nebulae, shining in blue and red within nests of brick-coloured stars. Steve Holmes of the Kitchener-Waterloo Centre photographed the pair from an observing site near Listowel, Ontario. Exposure was 60×2m using a Canon 5DII and a 200-mm f/2.8 lens.





# Journal

The *Journal* is a bi-monthly publication of The Royal Astronomical Society of Canada and is devoted to the advancement of astronomy and allied sciences.

It contains articles on Canadian astronomers and current activities of the RASC and its Centres, research and review papers by professional and amateur astronomers, and articles of a historical, biographical, or educational nature of general interest to the astronomical community. All contributions are welcome, but the editors reserve the right to edit material prior to publication. Research papers are reviewed prior to publication, and professional astronomers with institutional affiliations are asked to pay publication charges of \$100 per page. Such charges are waived for RASC members who do not have access to professional funds as well as for solicited articles. Manuscripts and other submitted material may be in English or French, and should be sent to the Editor-in-Chief.

## Editor-in-Chief

Jay Anderson  
203 – 4920 Dundas St W  
Toronto ON M9A 1B7, Canada  
Email: editor@rasc.ca  
Web site: [www.rasc.ca](http://www.rasc.ca)  
Telephone: (416) 924-7973  
Fax: (416) 924-2911

## Associate Editor-in-Chief

Nicole Mortillaro  
Email: nmortillaro@gmail.com

## Associate Editor, Research

Douglas Hube  
Email: dhube@phys.ualberta.ca

## Associate Editor, General

Michael Attas  
Email: attasm@aecl.ca

## Assistant Editors

Michael Allen  
Martin Beech  
Dave Chapman  
Ralph Chou  
Ralph Croning  
Dave Garner  
Patrick Kelly  
Gail Wise

## Editorial Assistant

Suzanne E. Moreau  
Email: semore@sympatico.ca

## Production Manager

James Edgar  
Email: james@jamesedgar.ca

## Contributing Editors

Jim Chung (Cosmic Contemplations)  
John Crossen (Rising Stars)  
Ted Dunphy (It's Not All Sirius)  
Geoff Gaherty (Through My Eyepiece)  
Dave Garner (On Another Wavelength)  
Blair MacDonald (Imager's Corner)  
Curt Nason (Astrocryptic)  
Andrew I. Oakes (News Notes)  
John R. Percy (John Percy's Universe)  
Randall Rosenfeld (Art & Artifact)  
Leslie J. Sage (Second Light)  
Rick Saunders (Cheap Stuff From China)  
David Turner (Reviews)

## Proofreaders

Ossama El Badawy  
Margaret Brons  
Angelika Hackett  
Terry Leeder  
Kim Leitch  
Suzanne Moreau

## Design/Production

Michael Gatto, Grant Tomchuk  
Email: gattotomatto@eastlink.ca,  
granttomchuk@eastlink.ca

## Advertising

Email: mempub@rasc.ca

## Printing

Canselmdc  
[www.cansel.ca](http://www.cansel.ca)

The *Journal* of The Royal Astronomical Society of Canada is published at an annual subscription rate of \$93.45 (including tax) by The Royal Astronomical Society of Canada. Membership, which includes the publications (for personal use), is open to anyone interested in astronomy. Applications for subscriptions to the *Journal* or membership in the RASC and information on how to acquire back issues of the *Journal* can be obtained from:

The Royal Astronomical Society of Canada  
203 – 4920 Dundas St W  
Toronto ON M9A 1B7, Canada

Email: [nationaloffice@rasc.ca](mailto:nationaloffice@rasc.ca)  
Web site: [www.rasc.ca](http://www.rasc.ca)  
Telephone: (416) 924-7973  
Fax: (416) 924-2911



Canadian Publications Mail Registration No. 09818

Canada Post: Send address changes to 203 – 4920 Dundas St W, Toronto ON M9A 1B7

Canada Post Publication Agreement No. 40069313

We acknowledge the financial support of the Government of Canada through the Canada Periodical Fund (CPF) for our publishing activities.

**Canada**

© 2014 The Royal Astronomical Society of Canada.

All rights reserved. ISSN 0035-872X



**Mixed Sources**  
Product group from well-managed  
forests and other controlled sources  
[www.fsc.org](http://www.fsc.org) Cert no. SW-COC-005174  
© 1996 Forest Stewardship Council

## News Notes / En manchettes

Compiled by Andrew I. Oakes

### Analysis of Martian sediment adds to habitability speculation

New insights are emerging concerning the planet Mars and the likelihood of its past habitability. This information is surfacing from the first detailed examination of clay mineralogy found in its original setting on that planet. The insights come from the Chemistry and Mineralogy X-Ray Diffraction and Fluorescence (CheMin XRD/XRF) instrument on NASA's rover "Curiosity," which has analyzed Martian sedimentary rock samples collected at Yellowknife Bay in Gale Crater.

According to David T. Vaniman, a senior scientist with the Planetary Science Institute (PSI) who is leading the research, the *in situ* X-ray diffraction results have revealed the presence of smectite, a type of clay mineral typical of soils and sediments that have not been deeply buried, heated, or otherwise altered. "The X-Ray diffraction data are also important for what they do not detect—clay minerals such as chlorite or illite that would have formed in strongly alkaline or hydrothermal fluids," said Vaniman.

## The Royal Astronomical Society of Canada

### Vision

To inspire curiosity in all people about the Universe, to share scientific knowledge, and to foster collaboration in astronomical pursuits.

### Mission

The Royal Astronomical Society of Canada (RASC) encourages improved understanding of astronomy for all people, through education, outreach, research, publication, enjoyment, partnership, and community.

### Values

The RASC has a proud heritage of excellence and integrity in its programs and partnerships. As a vital part of Canada's science community, we support discovery through the scientific method. We inspire and encourage people of all ages to learn about and enjoy astronomy.



Vaniman discussed the research at a December 2013 press conference at an American Geophysical Union meeting in San Francisco. The research and subsequent paper feature the first analysis of a complete mineral assemblage in Martian sediment that accounts for all of the associated debris that settled into a lake, as well as minerals formed in the lake and after it dried out.

This complete mineral analysis is considered important not only for what is seen but also for what is not present. “Unlike the sediments that the Mars Exploration Rover Odyssey has found at *Meridiani Planum*, the Gale Crater mudstone lacks iron sulfates that indicate an acidic environment,” Vaniman said. “The only sulfates found in the mudstone are calcium sulfates, associated with veins that formed after the lake was gone and not indicative of an acidic system. The mudstone mineralogy is consistent with a geochemically benign and potentially habitable environment.”

Funding for Vaniman’s research is the result of a cooperative agreement from NASA’s Mars Science Laboratory mission under a subcontract to NASA Ames Research Center.

## First-light images better by almost a factor of 10

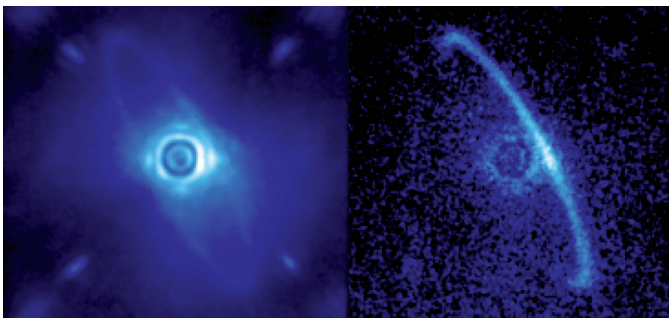

Figure 1 — The Gemini Planet Imager’s first-light image of the light scattered by a disk of dust orbiting the young star HR4796A. Left image shows normal light; right image shows only polarized light. Image: Gemini Planet Imager, Lawrence Livermore National Laboratory

The world’s most advanced instrument for directly imaging and analyzing planets orbiting stars far beyond the Solar System is now collecting long-travelled, reflected light from distant worlds. The Gemini Planet Imager (GPI) is capable of high-contrast imaging to better study faint planets or dusty disks next to bright stars. It had its first-light run in November 2013.

Lawrence Livermore National Laboratory in Livermore (LLNL), California, oversaw a multi-institutional team for nearly a decade in the design, engineering, building, and optimization of the GPI instrument. LLNL released the first images at the 223rd meeting of the American Astronomical Society in Washington, D.C., in early January 2014.

“Even these early first-light images are almost a factor of 10 better than the previous generation of instruments,” said Bruce Macintosh of LLNL, who led the team that built the instrument. “In one minute, we were seeing planets that used to take us an hour to detect.”

GPI is the first fully optimized planet imager, designed from the ground up for exoplanet imaging and is deployed on one of the world’s biggest telescopes, the 8-metre Gemini South telescope in Chile. To probe the environments of distant stars in a search for planets required the development of next-generation, high-contrast adaptive optics (AO)—sometimes referred to as “extreme AO.”

Direct imaging of planets is challenging because planets such as Jupiter are a billion times fainter than their parent stars. “Detection of the youngest and brightest planets is barely within reach of today’s AO systems,” Macintosh said. “To see other solar systems, we need new tools.”

The GPI is considered the world’s “most sophisticated” astronomical system for compensating for turbulence in the Earth’s atmosphere—an ongoing problem for ground-based telescopes.

GPI features include:

- Sensing atmospheric turbulence and correcting it with a 2-centimetre-square deformable mirror with 4000 actuators;
- Construction of the deformable mirror using etched silicon, similar to microchips, rather than the large reflective glass mirrors used on other AO systems, allowing the system to be compact and stable;
- The new mirror corrects for atmospheric distortions by adjusting its shape 1000 times per second with an accuracy better than 1 nanometre; and
- The capability to directly image extra-solar planets that are 1 million to 10 million times fainter than their host stars.

The first observations in November 2013 targeted previously known planetary systems—the four-planet HR8799 system (co-discovered by an LLNL-led team at the Gemini and Keck Observatory in 2008) and the Beta Pictoris system, among others. GPI also obtained the first-ever spectrum of the very young planet Beta Pictoris b.

Utilizing the instrument’s unique polarization mode, the first-light team looked at starlight scattered by tiny particles in order to study a ring of dust orbiting the very young star HR4796. Previously, only the edges of this dust ring (which may be the debris remaining from planet formation) could be seen. With GPI, astronomers followed the entire circumference of the ring. According to LLNL engineer Lisa Poyneer, who developed the algorithms used to correct for atmospheric



turbulence and led the testing of the adaptive-optics system in the laboratory and at the telescope, GPI's performance requirements are extremely challenging. "As a result, the AO system features several original technologies that were designed specifically for exoplanet science," she said.

GPI detects infrared radiation from young Jupiter-like objects in wide orbits, the equivalent of the giant planets in our Solar System, not long after their formation.

NASA's *Kepler* mission, a complementary exoplanet-imaging initiative, was designed to be sensitive to small planets close to their parent star and focused on mature stars. It completed its prime mission in November 2012 and began a four-year extended mission at that time that ran into serious technical problems in 2013.

### Three-body system includes fast-spinning pulsar

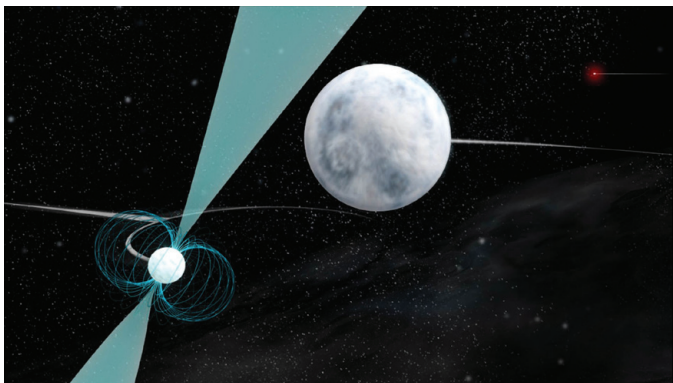

Figure 2 — A millisecond pulsar, left foreground, is orbited by a hot, white dwarf star, centre, both of which are orbited by another, more-distant and cooler white dwarf, top right. The foreground pulsar is spinning at 366 revolutions per second. Image: Bill Saxton; NRAO/AUI/NSF

Astronomers are probing a range of cosmic mysteries—including the nature of gravity itself—thanks to a newly discovered system of two white-dwarf stars and a superdense pulsar. The objects in the three-body system are packed within a space estimated to be smaller than the Earth's orbit around the Sun. The superdense pulsar represents the first millisecond pulsar found in such a system. Astronomers immediately recognized that the pulsar provides a unique opportunity to study the effects and nature of gravity. An international team, which includes University of British Columbia (UBC) astronomer Ingrid Stairs, reported their findings in the journal *Nature* early in January 2014.

The three-body system provides the team of scientists with the best opportunity to date to discover a violation of a key concept in Albert Einstein's general theory of relativity: the strong equivalence principle. It states that the effect of gravity on a body does not depend on the nature or internal structure of that body.

According to Stairs, the team can, by doing very high-precision timing of the pulses coming from the pulsar, test for such a deviation from the strong equivalence principle at a sensitivity several orders of magnitude greater than ever before available. "Finding a deviation from the strong equivalence principle would indicate a breakdown of general relativity and would point us toward a new, revised theory of gravity," said Stairs, who is with UBC's Department of Physics and Astronomy.

"This triple system gives us a natural cosmic laboratory far better than anything found before for learning exactly how such three-body systems work and potentially for detecting problems with general relativity that physicists expect to see under extreme conditions," said Scott Ransom of the National Radio Astronomy Observatory (NRAO) and the scientist leading the study.

Current scientific theory outlines the following scenario:

- When a massive star explodes as a supernova and its remains collapse into a superdense neutron star, some of its mass is converted into gravitational binding energy that holds the dense star together.
- The strong equivalence principle notes that this binding energy will still react gravitationally as if it were mass. All alternatives to general relativity hold that it will not.
- Under the strong equivalence principle, the gravitational effect of the outer white dwarf would be identical for both the inner white dwarf and the neutron star.
- If the strong equivalence principle is invalid under the conditions in this system, the outer star's gravitational effect on the inner white dwarf and the neutron star would be slightly different and the high-precision pulsar timing observations could easily show that.

Anne Archibald of the Netherlands Institute for Radio Astronomy and one of the authors of the study has noted that the team made some of the most accurate measurements of masses in astrophysics. "Some of our measurements of the relative positions of the stars in the system are accurate to hundreds of metres," said Archibald, who led the effort to use the measurements to build a computer simulation of the system that can predict its motions.

The observational program used the National Science Foundation's Green Bank Telescope, the Arecibo radio telescope in Puerto Rico, and the Westerbork Synthesis Radio Telescope in the Netherlands. They also studied the system using data from the Sloan Digital Sky Survey, the *GALEX* satellite, the WIYN telescope on Kitt Peak, Arizona, and the *Spitzer Space Telescope*.

An American graduate student using the National Science Foundation's Green Bank Telescope originally uncovered the pulsar, which is found 4200 light-years from Earth and spins



nearly 366 times per second. The pulsar is in close orbit with a white-dwarf star, and the pair are in orbit with another, more-distant white dwarf.

## Jade Rabbit leaves fresh tracks on Moon

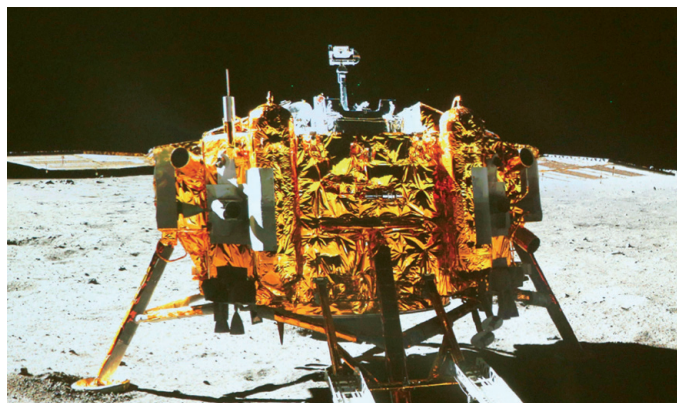

Figure 3 — The Chang'e lander photographed by the on-board camera of the "Yutu" or "Jade Rabbit" rover, soon after landing. Photo/Xinhua, Ding Lin.

The People's Republic of China is now the third country to successfully soft-land on the Moon. China's lunar probe *Chang'e-3* soft-landed on the Moon on 2013 December 14 and released its rover, Yutu or Jade Rabbit, on December 15. Over a period of two months, the lunar probe successfully conducted scientific analysis of the Moon's soil below the surface, utilizing a robotic arm requiring millimetre-level precision.

Named after the white pet rabbit of Chang'e, the lunar goddess in ancient Chinese mythology, Yutu ran into technical trouble just before it entered its second dormancy period on 2014 January 25. Although mission scientists at the Beijing Aerospace Control Center in Beijing were concerned that the rover might not be able to survive the extremely low night temperatures, lower than  $-180^{\circ}\text{C}$ , the rover managed to come back to life in mid-February. Experts had been working to verify the cause of its mechanical malfunction.

The rover has already passed its design life-span of three months. Currently unable to move due to unresolved mechanical problems, Yutu remains at a distance of about 100 metres from the lunar lander. However, it is still able to communicate and send back data and photos. So far, the rover has found 11 chemical elements in the soil, including magnesium, aluminium, titanium, and iron.

*Chang'e-3* is part of the second phase of the Chinese Lunar Exploration Program, which includes orbiting, landing, and returning to the Earth.

Chinese legend has it that, after swallowing a magic pill, Chang'e took her pet and flew toward the Moon, where she became a goddess, and has lived there with the white jade rabbit ever since.

Since the United States' last manned mission of *Apollo 17* ended in 1972, the Moon has been visited by only unmanned spacecraft. Orbital missions have been dominant, with lunar orbiters being sent by Japan, China, India, the United States, and the European Space Agency since 2004. The post-*Apollo* era also has seen two rover missions: the final Soviet Lunokhod mission in 1973 and now China's *Chang'e 3* mission.

## Top astronomers mentor university students

The two institutions may be an ocean apart and located on separate continents, but the Dunlap Institute for Astronomy and Astrophysics at the University of Toronto and the Vatican Observatory at Castle Gandolfo, Italy, have something in common for the summer of 2014.

Each institution is offering a summer school for a select group of university students, the purpose of which is to learn more about various aspects of astronomy. The participating students in the respective locations will listen to invited instructors—all recognized specialists in their specific fields of study—and participate in various hands-on activities.

The Dunlap Institute's annual, five-day summer school (from August 10 to 15) offers an introduction to cutting-edge

**SERVING AMATEUR ASTRONOMERS FOR OVER 22 YEARS!**

**toll-free 1-800-580-7160**  
**info@khanscope.com**

**www.khanscope.com**

**All Major Brands of Telescopes including:**  
Meade | Celestron | TeleVue | Coronado | APM  
SkyWatcher | William Optics | Rigol | Baader  
Nikon | Antares | Telrad | Denkmeier | Equinox  
Thousand Oaks | Kendrick | Lunt Solarsystems  
TeleGizmos | Ioptron | Sky Pub & Others

**NEW | USED | TRADE-INS**  
**WE SHIP CANADA WIDE**

**KHAN SCOPE CENTRE**

3243 Dufferin Street, Toronto, ON M6A 2T2  
Phone: 416 783 4140 | Fax: 416 352 1701



astronomical instrumentation for current and future telescope facilities. Headlined as an “Introduction to Astronomical Instrumentation—First Light on the Decade’s Most Innovative Instruments,” the summer school is designed around both the lecture format and interactive laboratory activities led by world-class astronomers specializing in the development of astronomical instruments.

The program introduces students to the basic principles of optics and detectors, as well as to advanced topics in instrument design and development. It includes a focus on laboratory, computer, and data acquisition skills.

Students attending the Dunlap Institute’s Summer School will:

Learn basic principles of optical, infrared, and radio instrumentation;

- Learn how detectors and spectrographs work;
- Attend a hands-on Fourier Transform Spectrometer lab;
- Learn in lecture and hands-on laboratory sessions;
- Work with students from around the world;
- Learn about a career in instrumentation;
- Learn from leaders in the field of astronomical instrumentation; and
- Attend professional development sessions, including a mentoring lunch for female students.

Dunlap’s invited instructors include René Doyon, Université de Montréal; James Graham, University of California, Berkeley; Olivier Guyon, University of Arizona, Subaru National Observatory, JPL; Phil Hinz, University of Arizona; Anna Moore, California Institute of Technology; David Naylor, University of Lethbridge; and Christine Wilson, McMaster University.

The Vatican Observatory’s 2014 Summer School in Observational Astronomy and Astrophysics, will focus on a different topic—“Galaxies: Near and Far, Young and Old.” Participating faculty and special invited speakers will present a comprehensive series of lectures and hands-on projects at the Papal summer villa. Field trips to sites of historical interest to astronomy are also part of the program.

The students attending the summer school are expected to be in upper-level university classes or in their beginning years of graduate studies, have mastered the fundamentals of astrophysics, and considering the possibility of future careers in astronomy or astrophysics.

The Vatican Observatory’s faculty members include John Stocke, University of Colorado, Boulder, Colorado; José G. Funes, S.J. (Director), Vatican Observatory; Guy Consolmagno, S.J. (Dean), Vatican Observatory; Christopher Carilli,



Figure 4 – The poster for the Vatican Observatory’s summer school.

Very Large Array, Socorro, New Mexico; Michele Trenti, Cambridge University, UK; and Jacqueline van Gorkom, Columbia University, New York.

During the four-week summer session, topics to be covered include:

- Introduction to galaxies near and far;
- Basic properties of nearby galaxies—masses and star formation, gas content, stellar ages and galaxy evolution, numerical models;
- Distant galaxies as seen by the *Hubble Space Telescope*
- Distant galaxies as seen by EVLA & ALMA;
- The most distant galaxies and the Dark Ages—observations and models;
- Promise of low-frequency radio arrays; and
- Promise of JWST.

The Vatican Observatory’s summer school runs from 2014 June 1 to 27.

*Andrew I. Oakes is a RASC member who lives in Courtice, Ontario. \**



## Solar-Motion Correction in Early Extragalactic Astrophysics

Domingos Soares and Luiz Paulo R. Vaz  
Departamento de Física, ICEX, UFMG—C.P. 702  
30123-970, Belo Horizonte, Brazil

### Abstract.

Redshift observations of galaxies outside the Local Group are fairly common in extragalactic astrophysics. Because redshifts are usually interpreted as arising from radial velocities, they must be corrected by removing the contributions caused by solar motion. We discuss the details of such correction in the way it was performed by the American astronomer Edwin Hubble in his 1929 seminal paper. The investigations of spiral nebulae undertaken by the Swedish astronomer Knut Lundmark, in 1924, are also considered in this context.

### 1 Introduction.

The light of distant galaxies—at least outside the Local Group—presents to the observer, especially to the spectroscopist, a singular feature discovered by the American astronomer Vesto Slipher (1875-1969) in the early decades of the 20th century: the position of the spectral lines of the chemical elements are, in the great majority of cases, systematically displaced to wavelengths larger than those measured for the same elements (at rest) in Earthly laboratories. Because the shifts are most often in the direction of larger wavelengths, they are called redshifts because, in the visible solar spectrum, red has the larger wavelength. Such a nomenclature is adopted even when the object's spectrum is outside the visible range. Less frequently, there is also the blueshift, whose definition is analogous to the redshift.

What is the cause of the redshifts of galaxies? Strictly speaking, this is still a question in dispute. One can, however, adopt the most obvious hypothesis, namely, that they originate from the motion of the galaxies away from the observer, the so-called Doppler Effect. Redshifts are usually represented by the letter  $z$ . For  $z < 0.1$ , the recession velocity is then given by  $v \cong cz$ , where  $c$  is the speed of light in vacuum (Soares 2009, Figure 4).

Observations are done from the Earth, which has a rotational motion that causes days and nights and an orbital revolution

about the Sun. These velocities are variable, depending on the time of the observation, but have amplitudes of 0.5 km/s and 30 km/s respectively, which are, in general, much smaller than galaxy velocities. Even so, galaxy velocity observations are corrected for these motions and thus become heliocentric velocities, referred to the Sun.

One must, next, consider the motion of the Sun. This consists of the motion inside the Milky Way plus the motion of the Milky Way with respect to the general field of galaxies, or, as the American astronomer Edwin Hubble (1936, p. 106) prefers “with respect to the nebulae.” The observations of galaxies are expressed, as we saw, “with respect to the Sun,” and in order to have the motion of the galaxies with respect to the general field of galaxies, one might remove the motion of the Sun with respect to this same field. We shall describe this procedure, in what follows, according to the method quantitatively prescribed by Hubble in his influential article of 1929 and, rather clearly described in a qualitative way, in his book entitled *The Realm of Nebulae* (Hubble 1936). In section 3, we apply Hubble's method to the galaxy sample of Knut Lundmark, Hubble's contemporary at astronomy. We conclude with general remarks in section 4.

### 2 Solar-motion corrections.

In *The Realm of the Nebulae*, Hubble explains how the motion of the Sun influences the observed motion of the “nebulae” (*i.e.* of the galaxies; see Hubble 1936, p. 106):

*Each observed velocity was thus a combination of (a) the “peculiar motion” of the nebula, as the individual motion is called, and (b) the reflection of the solar motion (a combination of the motion of the sun within the stellar system [i.e., inside the Milky Way Galaxy] and the motion of the stellar system with respect to the nebulae). If sufficient nebulae were observed, their random peculiar motions would tend to cancel out, leaving only the reflection of the solar motion to emerge from the totality of the data.*

...

*Actually, the residual motions were still large and predominantly positive. The unsymmetrical distribution indicated the presence of some systematic effect in addition to the motion of the sun [with respect to the nebulae].*

The above-mentioned “systematic effect” was modelled by Hubble simply as  $Kr$ —a constant times the distance to the galaxy—a model different from others in his days, who added quadratic terms and even logarithmic ones in  $r$ .

Quantitatively, we follow Hubble (1929). The velocity of a galaxy observed from Earth, after the heliocentric correction, may be written, according to classical relativity, as the composition of two velocities:



$$\vec{v} \equiv \vec{V}_{G\odot} = \vec{V}_{GR} + \vec{V}_{R\odot} . \quad (1)$$

The letter “R” represents the “reference frame of the nebulae.” The motion of the reference frame of the nebulae with respect to the Sun is given by the “reflection of the solar motion”—as Hubble writes—with respect to the reference frame of the nebulae, that is:

$$\vec{V}_{R\odot} = (X, Y, Z) = - \vec{V}_{\odot R} = (-X_{\odot}, -Y_{\odot}, -Z_{\odot}) . \quad (2)$$

On page 170 of Hubble (1929), the letter “v” represents the *radial* velocity of a galaxy measured with respect to the Sun, in other words, it is one of the components of the velocity vector. According to the explanation given by Hubble above, we can then write the expression for v, wherein the “systematic effect” proportional to the distance and the “reflection of the solar motion” appear separately:

$$v = (\vec{v})_{radial} = Kr + (\vec{V}_{R\odot})_{radial} . \quad (3)$$

Figure 1 shows, in the equatorial system of coordinates, the velocity  $(X, Y, Z) = (-X, -Y, -Z)$  and the velocity v of a given galaxy. The coordinates  $\alpha$  and  $\delta$  in the figure are, respectively, the Right Ascension and the Declination of the galaxy.

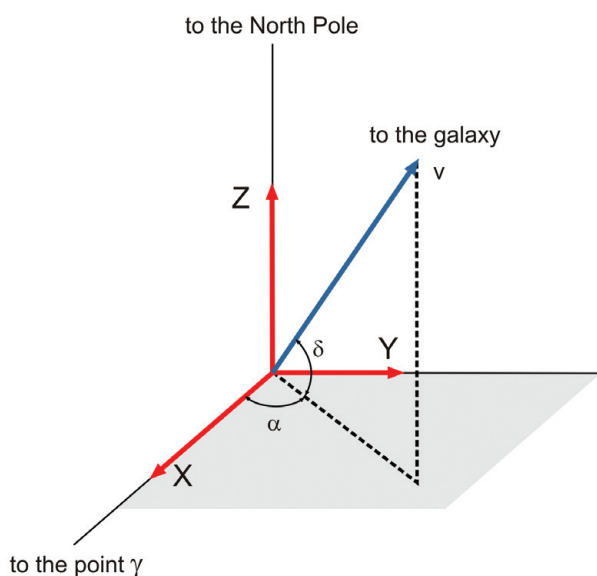

Figure 1 — The components X, Y, and Z of the velocity symmetrical to the Sun velocity, and the radial velocity, v, of a galaxy are displayed in the equatorial coordinate system. The galaxy’s right ascension is  $\alpha$  and its declination is  $\delta$ .

The projection of  $(X, Y, Z)$  on the line of sight of a given galaxy—the second term in the right-hand side of equation 3—can be derived from Fig. 1 and is explicitly shown below:

$$v = Kr + X \cos \alpha \cos \delta + Y \sin \alpha \cos \delta + Z \sin \delta . \quad (4)$$

This is the very same equation that appears on page 170 of Hubble (1929). Through it and the galaxy observations (velocities and distances) we can get the solar motion with respect to the reference frame of the galaxies:

$$\vec{V}_{\odot R} = (X_{\odot}, Y_{\odot}, Z_{\odot}) = (-X, -Y, -Z) . \quad (5)$$

We have in this problem four unknowns to be determined: K, X, Y, and Z. In general, one has many more than four observed galaxies, and the resulting system of equations turns out to be overdetermined (more equations than the number of unknowns). This is a rather common situation in astrophysics. For example, a binary stellar system can be spectroscopically observed in many orbital phases yielding a set of observations much larger than the number of unknowns of the problem (orbital inclination and eccentricity, mass ratio, etc.).

Next, we shall undertake such a procedure with the list of galaxies studied by who is regarded by many as one of the precursors of Hubble. In the end of the procedure we shall obtain the solar motion and the equivalent to the modern “Hubble’s constant” for the expansion of the galaxies.

### 3 The spiral nebulae of Knut Lundmark.

In 1924, the Swedish astronomer Knut Lundmark (1889-1958) published an article wherein he proposed to determine the radius of curvature of the space-time in light of the cosmological model put forward by the Dutch physicist Willem de Sitter (1872-1934) in 1917. De Sitter’s model predicted that light from a distant object should exhibit a redshift proportional to the object’s distance. The radius of curvature could be determined from the constant of proportionality. Usually, redshift was interpreted as originating from the recession velocity of the object, calculated through the Doppler Effect formula  $v=cz$ . In his paper, Lundmark discussed graphs of velocity  $\times$  distance for various classes of objects. We shall analyze his data for the so-called “spiral nebulae,” the modern spiral galaxies.

Figure 2 shows the data of Lundmark (1924, Table III). He determined the distances to the nebulae by comparing their apparent sizes and brightnesses with the size and brightness of M31, producing distances in terms of the distance to M31,  $d_{M31}$ , (see more details in Soares 2013). Adopting the modern



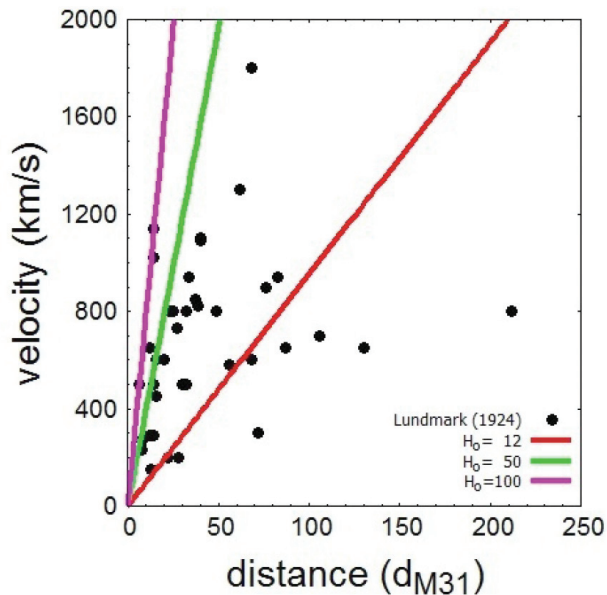

Figure 2 – The galaxies of Lundmark (1924, Table III) without solar-motion correction. Distances to the galaxies are given in units of  $d_{M31}$ , the distance to M31. Lines represent “Hubble’s laws” with different Hubble’s parameters, in (km/s)/Mpc, adopting the modern value of  $d = 784$  kpc. The slope  $H_0 = 12$  (km/s)/Mpc corresponds to the fitting of  $v = H_0 d$  to Lundmark’s data (see also Soares 2013). The accepted value of Hubble’s constant nowadays is 72 (km/s)/Mpc with an uncertainty of 10 percent (cf. Freedman et al. 2001 and Soares 2009).

value of  $d_{M31} = 784$  kpc (Stanek and Garnavich 1998), we superimpose on the data some relations of proportionality of the form  $v = H_0 d$ , where  $H_0$  represents the modern definition of “Hubble’s constant.” The value  $H_0 = 12$  (km/s)/Mpc is the slope of the line fitted to Lundmark’s data, but forced to cross the origin. A linear fit to the data has a positive interception with the velocity axis of approximately 600 km/s and a slope

of  $H_0 = 3$  (km/s)/Mpc. The interception with the velocity axis would indicate the contamination of the data by the solar motion. One can try then to remove the solar motion using the same proceeding adopted by Hubble in his work of 1929.

In order to remove the solar motion, we must solve an over-determined system of equations, as seen in the end of section 2. We have a model (with a set of  $N$  unknowns or parameters— $N=4$  in our case,  $K, X, Y, Z$ ) that must reproduce a series of  $M$  observations,  $M$  being much larger than  $N$ . It is this last feature that makes the system of equations to be called *overdetermined*.

Our problem consists in minimizing the differences between the prediction of the model (the right-hand side of equation 4) and the measurement of the observable (the radial velocity of a given galaxy, *i.e.* the left-hand side of equation 4). In practice, what we minimize is the sum of the squared differences between the prediction (which we may call calculated value) and the observed value. This is the classical method of least squares.

The results we obtained, by reproducing Hubble’s 1929 methodology, imply corrections in the observed velocities that, surprisingly, do not significantly affect the determination of the constant  $K$  (the modern “Hubble’s constant”). It is approximately the same whether we use the initial sample or the corrected one. To illustrate this aspect, we show in Figure 3, the diagrams  $V \times R$  for the sample of Lundmark (1924), without the negative velocities and, furthermore, without the elliptical and irregular galaxies, according to our present knowledge. Such galaxies are not appropriate to Lundmark’s method of distance calculation, which is based in the comparison of apparent size and brightness with M31. This sample has 30 galaxies.

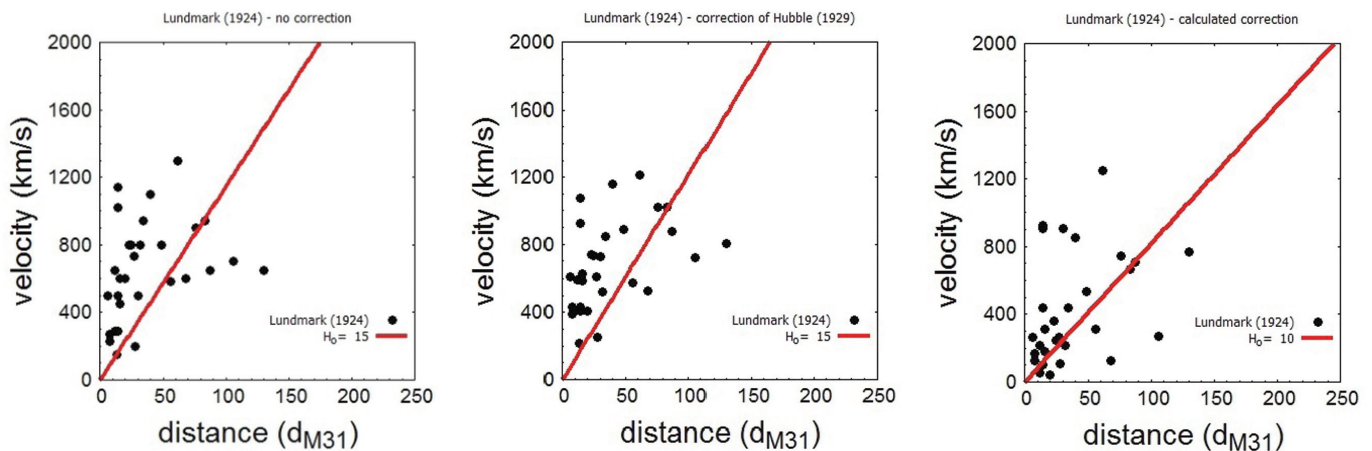

Figure 3 – The galaxies of Lundmark (1924), without galaxies with negative velocities (6) and without elliptical (6) and irregular (2) galaxies. From the 44 originally in Table III, 30 remain. The lines represent “Hubble’s laws” with different  $H_0$  parameters in units of (km/s)/Mpc, adopting the modern value of  $d_{M31} = 734$  kpc. The left panel shows galaxies without solar-motion correction, middle panel, corrected by Hubble’s 1929 solar motion, and the right panel, with the calculated solar-motion correction.

Figure 3 shows three diagrams: the sample without correction and a fit  $v=Kr$ ; the sample corrected by Hubble's 1929 solar motion and a fit  $v=Kr$ ; and the sample corrected for the solar motion, by the method of least squares applied to eq. 4 and the resulting line  $v=Kr$ . As we can see, in all three cases, Lundmark's determinations of Hubble's constant ( $H_0=15, 15, 10$ ) are not substantially different from each other. The values obtained are, however, smaller than the modern value of  $H_0=72$  (km/s)/Mpc. The values of  $H_0$  determined using Lundmark's galaxy data are closer to the accepted modern value than that found by Hubble ( $H_0 = 465\pm 50$  (km/s)/Mpc). Two factors contributed to the better performance of Lundmark's data: by his method of distances, which was simpler and more reliable than Hubble's; and by the comparison to the distance to M31, which was, of course, unknown at the time.

The correction of the solar motion, as laid down by Hubble, varies with the depth (distance) of the galaxy sample. The largest distances are, because of the largest difficulty of observation, the most affected by uncertainties. Accordingly, it would be interesting to select a nearby subsample of Lundmark's galaxies such that distances would be better estimated and would, moreover, be similar to Hubble's 1929 distances. Such a procedure would provide an opportunity to make a direct comparison with the result obtained by Hubble. We know now that Hubble underestimated his distances by a factor of  $\sim 10$ . Hubble's largest distance is 2.0 Mpc (see his Table 1); accordingly, we can restrict Lundmark's sample to galaxies closer than  $10 \times 2.0 = 20$  Mpc. Doing so results in a sample of 12 galaxies. We reanalyzed these data using the procedure of Figure 3 and the result is shown in Figure 4.

Again, as we can see in Figure 4, the solar-motion correction does not significantly affect the determination of  $H_0$ .

Incidentally, it is interesting to point out that the original sample of Hubble (excluding the negative velocities) without solar-motion correction gives a linear correlation  $v=Kr$ , with  $K=446$  (km/s)/Mpc, consistent with the value he calculated after solar-motion correction ( $K = 465\pm 50$ ).

Qualitatively, the solar motion obtained with Lundmark's reduced sample is compatible with the one obtained by Hubble. The solar-motion apex in Hubble ( $\alpha = 19$  hours and  $\delta = +40$  degrees) sits approximately in the direction of the star Vega, the brightest star of the Lyra constellation. With Lundmark's 12-galaxy sample, the apex sits nearby, at the boundary between Lyra and Vulpecula constellations ( $\alpha = 19$  hours and  $\delta = +23$  degrees). However, the uncertainty of distances in both samples almost makes such similarities irrelevant.

#### 4 Final remarks.

In modern relativistic cosmology, redshifts of distant objects are interpreted as the result of expanding space. For small values of  $z$ , as those discussed here, *i.e.*  $z \ll 1$ , both interpretations—the Doppler Effect and expanding space—are mathematically indistinguishable (see Soares 2009, Fig. 4). The influence of the solar motion on galaxy velocities is only physically meaningful within the interpretation of redshifts as originating from the Doppler Effect.

The idea that there might be a component of systematic motion in the nebula velocities, as mentioned in the beginning of section 2, was not Hubble's. It had been introduced by the German astronomer Carl Wilhelm Wirtz (1876-1939) in 1918, following the work that was already done in the determination of the solar motion with respect to the stars (Hubble 1936, p. 107). Wirtz assumed then the existence of

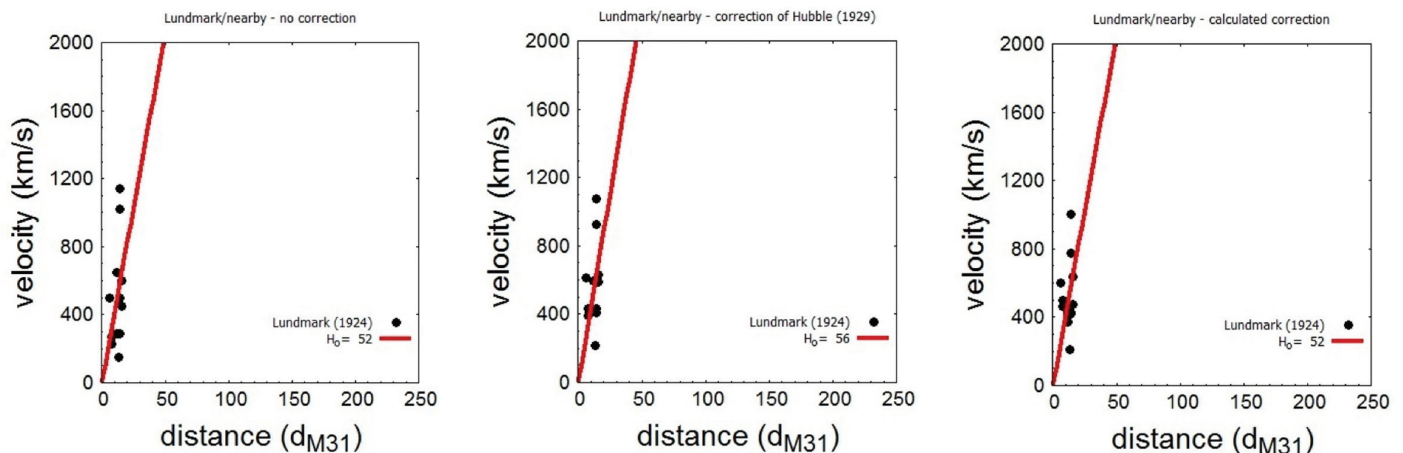

Figure 4 — The 12 nearest galaxies of Lundmark (1924), with distances consistent with Hubble's 1929 sample. The lines represent "Hubble's laws" with different  $H_0$  parameters in units of (km/s)/Mpc, adopting the modern value of  $d_{M31} = 734$  kpc. The left panel shows galaxies without solar-motion correction, middle panel corrected by Hubble's 1929 solar-motion, and right panel with the calculated solar-motion correction. The  $H_0$  parameters obtained in all cases are near the modern accepted value of  $H_0 = 72 \pm 10\%$  (km/s)/Mpc.



a  $K$ -term (or  $K$ -correction) as a constant velocity ( $K$  from the German *konstant*), which might be subtracted from the nebula velocities, before the solar-motion determination:

$$v = K + X \cos \alpha \cos \delta + Y \sin \alpha \cos \delta + Z \sin \delta . \quad (6)$$

where  $K$  is the velocity correction that should be applied to  $v$ . With such a correction and the removal of the solar motion, the situation of the velocity residuals of Wirtz's nebulae improved, but still was not entirely satisfactory. They did not distribute in a completely random way—as expected—and, in addition, the derived  $K$ -term was of about 800 km/s, intriguingly large and comparable to the resulting solar motion ( $\sim 700$  km/s).

The situation would considerably improve with the introduction of a  $K$ -correction term that varied with distance, as done by Hubble in 1929 (*cf.* eq. 4). The solar motion determined by him in such a way was of about 300 km/s in the approximate direction of Vega (Hubble 1936, p. 114), and the velocity residuals were satisfactorily random. Hubble's ingenuity was his decision in adopting the simplest hypothesis for the variable  $K$ -correction, namely, of the type  $Kr$ , while other astronomers got lost in much more complicated—and at that point unnecessary and even unjustifiable— $K(r)$  expressions. On the other hand, Hubble was aware that the relationship  $v=Kr$  was consistent with the prediction of de Sitter's cosmological model (Hubble 1929, p. 173).

As we have seen, solar-motion correction in the early extragalactic astrophysics did not turn out to be important in the determination of the theoretical expansion parameter, mainly because of the significant errors in distance determination. In modern extragalactic astrophysics and cosmology, however, distances and spectral shifts are determined to much better precision and solar-motion correction becomes a fundamental aspect of the evaluation of theoretical parameters.

Nowadays, the observations of galaxies outside the Local Group from a given observatory are submitted to two correc-

tions. First, as before, the heliocentric correction is done, and, in the second place, in contrast to what has been done above, the solar-motion correction is done with respect to the barycentre—or centroid—of the Local Group of galaxies. Velocities become then referred to the centre of the Local Group and may then be used in the investigations of extragalactic issues, such as the expanding-Universe problem. For the technical details of these corrections see, for example, the articles by Yahil, Tammann, and Sandage (1977) and by Karachentsev and Makarov (1996). ★

## References

- Freedman, W.L. *et al.* (2001). Final Results from the Hubble Space Telescope Key Project to Measure the Hubble Constant. *ApJ* 553, 47-72.
- Hubble, E. (1929). A relation between distance and radial velocity among extragalactic nebulae. *Proceedings of the National Academy of Sciences* 15, 168-173.
- Hubble, E. (1936). *The Realm of the Nebulae*. New York, NY: Dover.
- Karachentsev, I.D. & Makarov, D.A. (1996). The Galaxy Motion Relative to Nearby Galaxies and the Local Velocity Field. *AJ* 111, 794-803
- Lundmark, K. (1924). The determination of the curvature of space-time in de Sitter's world. *MNRAS* 84, 747-770.
- Soares, D. (2009). The age of the universe, the Hubble constant, the accelerated expansion and the Hubble effect. <http://arXiv.org/abs/0908.1864> .
- Soares, D. (2013). COSMOS:15Jan13 (in Portuguese). [www.fisica.ufmg.br/~dsoares/cosmos/13/cosmos1.htm](http://www.fisica.ufmg.br/~dsoares/cosmos/13/cosmos1.htm).
- Stanek, K.Z. & Garnavich, P.M. (1998). Distance to M31 with the Hubble Space Telescope and HIPPARCOS Red Clump Stars. *ApJ* 503, L131-L134.
- Yahil, A., Tammann, G.A., Sandage, A. (1977). The Local Group - The solar motion relative to its centroid. *ApJ* 217, 903-915.

One of us (DS) wishes to thank Alexandre Bagdonas Henrique for helpful discussion on Lundmark's work.

WWW

RASC Internet Resources

 Like us on facebook

 Follow us on Twitter @rasc

[www.rasc.ca](http://www.rasc.ca)  
 Visit the RASC Web site

[www.rasc.ca/discussion](http://www.rasc.ca/discussion)  
 Email Discussion Groups

[www.rasc.ca/contact](http://www.rasc.ca/contact)  
 Contact the National Office

[www.rasc.ca/news](http://www.rasc.ca/news)  
 RASCeNews

# Great Observatories

Klaus Brasch, *Unattached Member*  
(krbrasch@earthlink.net)

About ten years ago, Firefly Books, a Canadian publisher of quality popular science and nature books, asked me to translate a really unique work: *Les Grands Observatoires du Monde* by Serge Brunier and Anne-Marie Lagrange. Brunier is a prize-winning French journalist-author specializing in astronomy and Lagrange is a renowned astrophysicist and exoplanet expert. An engaging blend of science, history, and travelogue, the book reminded me that I had actually visited a number of those great observatories, as well as many other less-well-known astronomical institutions. What follows is a sampling of those I found most memorable.

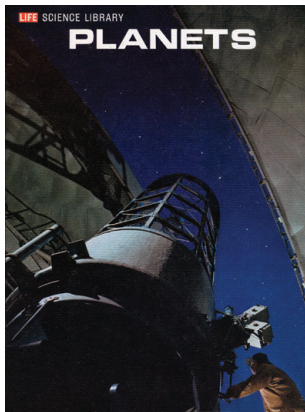

Figure 1 — The 74-inch DDO reflector as it appeared on the cover of *Planets*, a 1966 publication of the LIFE Science Library.

## David Dunlap Observatory

When the astronomy bug first bit me as a teenager in the late 1950s in Toronto, there was, of course, only one great astronomical “shrine”—the David Dunlap Observatory (DDO). I visited it quite often on public viewing nights and was thrilled to see it subsequently featured on the cover of the *Planets*, one of the engaging Time-LIFE series books, now long out of print (Figure 1). The sky was still dark enough then at Richmond Hill that the Milky Way was an impressive sight. I recall visiting

in the fall of 1956, during a particularly good opposition of Mars, hoping to get a glimpse of the Red Planet through the great 74-inch (1.88-m) reflector, and maybe, just maybe, its illusive “canals.” Much to my dismay, however, we were shown Alberio that evening; beautiful colours but not significantly more impressive than with my 3-inch refractor!

Sadly, of course, skies at Richmond Hill have progressively deteriorated since then, so much so that the facility was almost closed in 2007. Fortunately, closure has not happened and hopefully never will (Percy 2014). As the largest telescope on Canadian soil, once one of the largest in the world and a historic research facility, the DDO should continue to serve as an inspiration to astronomy enthusiasts and students everywhere.

After my family moved to Montréal in 1958, I became very engaged in astronomy at the Montréal Centre of the RASC, then one of the most active in Canada and indeed all of North

America. I made a number of fast friends there, including well-known JRASC columnist, Geoff Gaherty, with whom I am still in regular contact. While maintaining an interest in astronomy throughout my undergraduate and graduate student years, I was simply too busy becoming a biologist to stay active in the hobby. In fact, it was not until 1980, during a sabbatical leave from Queen’s University to southern California, that I again visited any major astronomical institutions. Some ten years later, when I took a permanent academic position at California State University, San Bernardino, I became even more familiar with them.

## Mt. Wilson Observatory



Figure 2 — Aerial view of Mt. Wilson Observatory showing the large dome of the Hooker and the smaller dome of the Hale telescope, respectively, as well as two solar towers at left. (Photo by NASA).

Famed Mt. Wilson Observatory (Figure 2), home to two legendary telescopes, the 60-inch (1.5-m) Hale and 100-inch

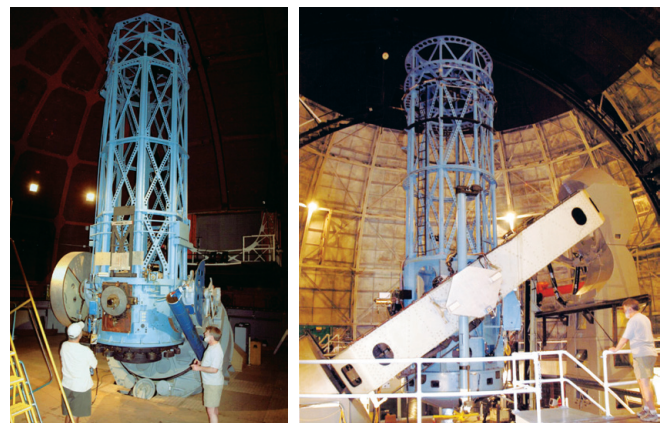

Figure 3 — The venerable 60-inch Hale telescope at Mt. Wilson as it appears today, ready for visual observing by visitors. (Photo by T. Dickinson).

Figure 4 — The legendary 100-inch Hooker telescope, used by Edwin Hubble and colleagues to prove unequivocally that spiral “nebulae” are distant galaxies and not part of the Milky Way, and leading to the realization that the Universe is expanding. (Photo by T. Dickinson).



(2.5-m) Hooker reflectors (Figures 3 and 4, respectively), was just a half-hour drive from our home. These classic instruments are best known for the fundamental spectrographic and photographic work of Edwin Hubble and colleagues in the 1920s and '30s, proving that spiral “nebulae” are in fact distant galaxies in our expanding Universe.

Conceived and founded in the early 1900s by George Ellery Hale, the observatory was funded by the Carnegie Institution and was a leading astronomical centre in the world for many decades. It is also home to two classic solar telescopes and was a pioneer of optical interferometry. Today it houses the Center for High Angular Resolution Astronomy (CHARA) array, used to directly image and study nearby stars (Figure 5).

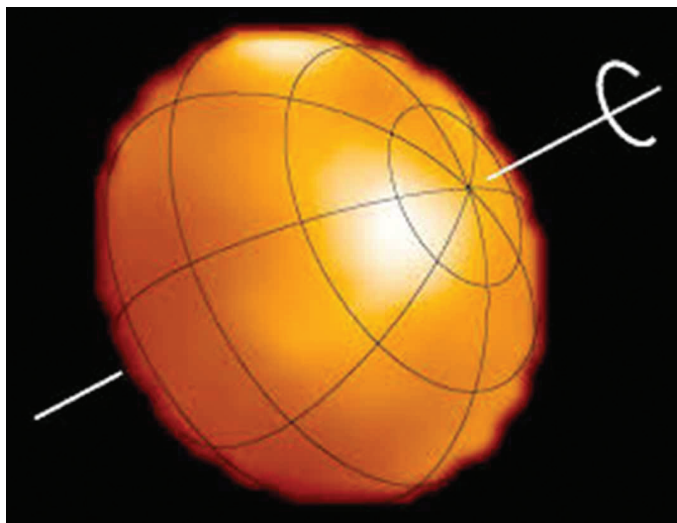

Figure 5 — Altair as directly imaged by the CHARA interferometer, showing axial tilt and rotation (image from wikicommons).

Although the skies at Mt. Wilson have deteriorated greatly since Hubble’s days, due to light pollution and smog from the Los Angeles basin, seeing conditions there are legendary. Thanks to a predominant westerly laminar air flow off the Pacific Ocean, the views atop the mountain are often rock steady. This was amply demonstrated when Terence Dickinson and I got an inside tour of the observatory a few years ago, which included an observing session with the 60-inch. As luck would have it, an inversion over Los Angeles resulted in a thick layer of fog across the basin that greatly attenuated the light below, providing us with spectacular views of several deep-sky objects and Uranus under 600× magnification. The planet’s jade-green colour was stunning, its tilted polar region was distinctly lighter in colour, and several of its moons were visible.

### Griffith Observatory

Griffith Observatory is another marvellous astronomical facility in Los Angeles (Figure 6). Noted more for its gorgeous



Figure 6 — Griffith Observatory seen from the main entrance area (image from wikicommons).

hilltop setting and Art Deco architecture, this museum, observatory, and science education centre, attracts thousands of visitors a year. Thanks to the generosity of Colonel G.J. Griffith and advice from such famed astronomical figures as George E. Hale and Russell W. Porter, the observatory, completed in 1935, was established with a strong mandate for public education. In 2007, the then-aging facility was totally refurbished and modernized with state-of-the-art exhibits and a new planetarium and space theatre while keeping its original solar telescope and classic Zeiss 12-inch (305-mm) refractor. No doubt due to its proximity to Hollywood, Griffith has been featured in numerous TV and movie productions. It has also benefited from support by many well-known personalities, including actor Leonard Nimoy of Star Trek fame and celebrity chef Wolfgang Puck.



Figure 7 — The imposing dome of the 200-inch Hale telescope as it appears near the summit of Mt. Palomar. This was by far the largest telescope in the world for some 45 years.

### Palomar Observatory

Established in 1948, Palomar Observatory (Figure 7) is owned and operated by the California Institute of Technology. Among its many notable instruments, it is home to several important telescopes: the 200-inch (5.1-m) Hale Reflector, the world’s largest for some 45 years; the historic 48-inch (1.2-m) Samuel Oschin Schmidt Telescope; and the Palomar Test-bed

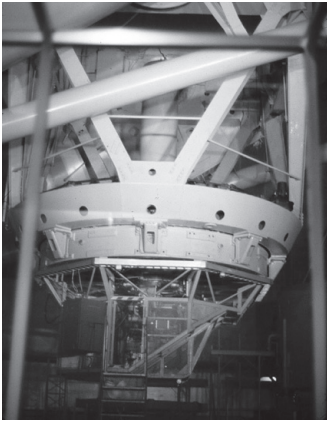

Figure 8 — Close-up view of the instrument cage under the mirror of the 200-inch telescope from the visitor window. A portion of the massive horseshoe mount is visible at the top left.

Interferometer. As with Mt. Wilson, George Ellery Hale was the prime mover behind the 200-inch reflector, and Russell W. Porter designed the giant dome. Located on Mount Palomar, 145 km southeast of Los Angeles, near San Diego, the observatory required development of entirely new optical, mechanical, and architectural technologies. Not only did its designers pioneer the honeycomb design for its 200-inch mirror, but they also developed the now-classic horseshoe equatorial mount. Although the history and engineering aspects of the Hale giant

have been amply documented, and many larger-diameter reflectors exist today, it remains an impressive sight up close and personal (Figure 8). Sadly, skies over Palomar Mountain have also deteriorated over time, though not as badly as Mt. Wilson, thanks to light-shielding ordinances among many of the surrounding communities. Because of those controls, much research is still carried on at the observatory today.

## Lick Observatory

Opened in 1888, thanks to a bequest from James Lick, then the wealthiest man in California, this observatory was one of the first to be permanently sited on a high mountain, Mt. Hamilton (Figure 9). Located just east of San Jose, it was home to the then-largest refractor in the world (Figure 10); the 36-inch



Figure 9 — The dome and main entrance of the 36-inch refractor at Lick Observatory on the summit of Mt. Hamilton, east of San Jose, California.

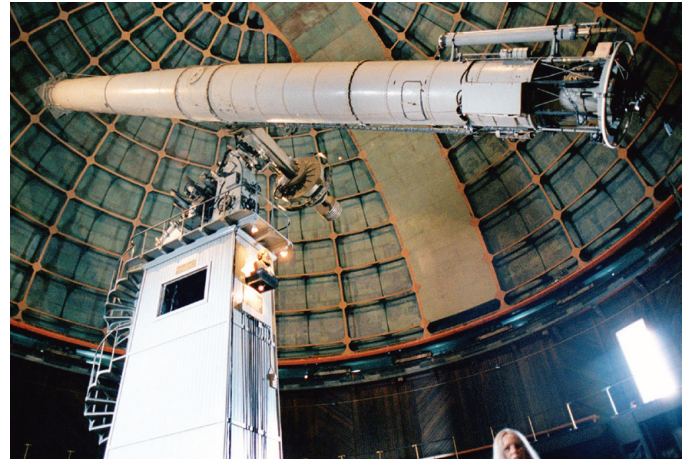

Figure 10 — The imposing 36-inch Clark at Lick Observatory, the second largest refractor in the world. The foreground person provides scale.

(91-cm) Alvan Clark objective lens is superseded only by the 40-inch (102-cm) Yerkes refractor established in 1897. Lick Observatory is owned and operated by the University of California and is home to several notable telescopes and a number of modern instruments. Noteworthy among these are the Crossley 36-inch refractor, donated to Lick in 1896 by its English owner and then used extensively by James E. Keeler for his pioneering photographic work of diffuse nebulae.

Historically the observatory is credited with the discovery of several Jovian moons and more recently, the discovery of numerous extra-solar planets, using its 120-inch (3-m) Shane reflector (Figure 11) and the 2.4-m (94-inch) Automated Planet Finder. Unfortunately, sky conditions there have also gradually deteriorated, and in 2014, the University of California announced its intention to terminate funding for the observatory by 2018 unless alternate funding or partners emerge.

## Lowell Observatory

Founded by wealthy Bostonian Percival Lowell in 1894, the observatory remains, to this day, the only major private institution of its kind in the U.S.A. As outlined previously (Brasch

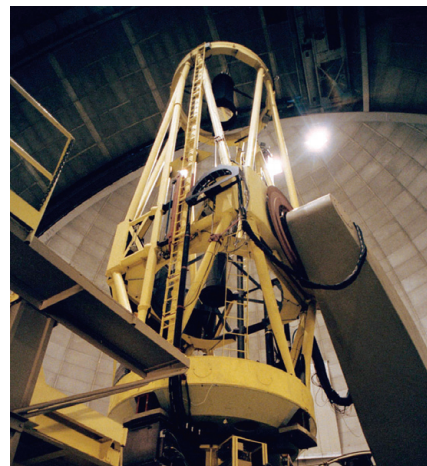

Figure 11 — The 120-inch Shane reflector at Lick Observatory, used primarily for exoplanet searches.



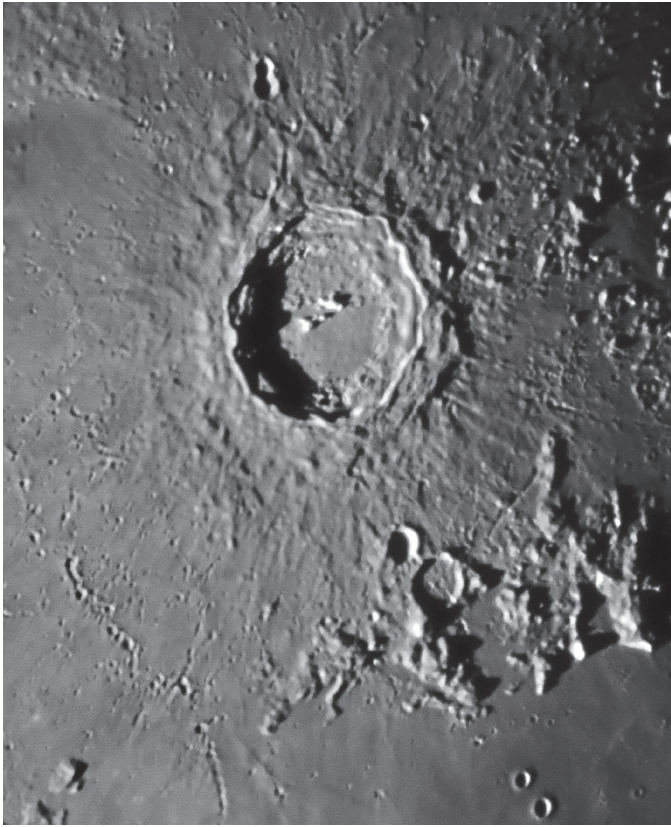

Figure 12 — Close-up of the lunar crater Copernicus imaged by the author with the 24-inch Clark refractor at Lowell Observatory.

*et al.* 2013), Lowell enjoys a rich and colourful history that includes discovery of the recession of galaxies by Vesto Slipher in 1914, and of Pluto by Clyde Tombaugh in 1930. The site of a historic 24-inch (61-m) Clark refractor and several other important telescopes, the observatory is also home to the Navy Precision Optical Interferometer (NPOI) in partnership with the U.S. Naval Observatory and the U.S. Naval Research Laboratory. In 2013, Lowell Observatory's state-of-the-art 4.3-m Discovery Channel Telescope became operational and catapulted the institution into a cutting-edge research facility once again.

In addition to specializing in Solar System research, galaxy evolution, and exoplanets, among other areas, Lowell welcomes some 80,000 visitors annually, many of whom are treated to pristine skies and views through the 24-inch Clark and other telescopes. Though some 120 years old, the venerable Clark has superb optics, ideal for both visual and photographic work (Figure 12).

## McDonald Observatory

McDonald Observatory, reigning atop the mountains of west Texas under very dark skies, was established in 1933 through an endowment by banker W.J. McDonald (Figure 13). Originally administered by the University of Chicago, it was transferred to the University of Texas at Austin in the 1960s.



Figure 13 — Panoramic view of McDonald Observatory in the Davis Mountains of west Texas. The dome of the 9.3-m Hobby-Eberly telescope is on the peak at left and the original suite of domes on Mt. Locke at right (image from wikicommons).



Figure 14 — Dome of the Otto Struve Telescope at McDonald Observatory. When dedicated in 1939, this 88-inch reflector was the second largest in the world.

Its first major telescope, an 82-inch (2.1-m) reflector, was dedicated in 1939 (Figure 14) and was the second largest in the world at the time. Subsequently named after famed astronomer Otto Struve, the observatory's first director, the telescope was joined by the 107-inch (2.7-m) Harlan Smith reflector in 1968 and in 1997 by the 9.3-m Hobby-Eberly Telescope, one of the largest in the world. The latter has a segmented mirror





Figure 15 – View of Kitt Peak National Observatory on the way up the Quilan Mountains of southern Arizona. The largest dome houses the 4-m Mayall Telescope.

consisting of 91 hexagonal elements and is used principally for spectroscopic work.

Among other things, McDonald Observatory is widely known for operating one of the first lunar laser-ranging facilities, for its very popular Star Date radio program, and for hosting star parties and other educational events at its modern visitor centre. The observatory is also near Fort Davis and the Prude Ranch, home to the very popular Texas Star Party.

### Kitt Peak National Observatory (KPNO)

Located about 90 km southwest of Tucson, Arizona, the multiple domes and other structures of KPNO are an impressive sight from afar, perched atop the highest peak (2096 m) of the Quilan Mountains. The observatory was founded in 1958 on land leased by the National Science Foundation (NSF) from the Tohono O’odham Nation. Kitt Peak is administered by the Association of Universities for Research in Astronomy (AURA), which also manages several other facilities, including the Space Telescope Science Institute, the National Optical Astronomy Observatory (NOAO), and several other major observatories. The site is home to 24 optical telescopes, including the 4-m Mayall reflector and the McMath-Pierce Solar Telescope, the world’s largest of its type. Two radio telescopes are also there, making it the largest assembly of astronomical telescopes in the world (Figure 15).

In addition to its function as a national research centre, the observatory also partakes in several public and educational programs. Amateurs can rent telescope time for observing and astro-imaging with dedicated telescopes or spend overnight observing sessions on the mountain. Sadly, the NSF recently announced it will cease support of this now rather dated facility by 2018 due to federal budget constraints and support

for other major projects in Chile and Hawaii. Hopefully that too can be averted or tempered, since Kitt Peak is still a major research facility for smaller universities and for graduate student training.

### Siding Spring

In 1999 and 2000, Terence Dickinson, Alan Dyer, the late Mike Mayerchak, and I were granted permission to spend two successive photo-observing sessions at Australia’s largest and most important optical observatory.



Figure 16 – Star trails around the south celestial pole with the dome of the 3.9-m Anglo-Australian Telescope and adjacent buildings. The foreground red light shows one of our group members walking by.

Located some 400 km from Sidney, NSW, Siding Spring Observatory is perched about 1100 metres above sea level and overlooks the spectacular vista of Warrumbungle National Park. The observatory is home to several telescopes, including the 3.9-m Anglo Australian Telescope (AAT) (Figure 17) and the 1.2-m UK Schmidt, a near-twin of the famous Palomar



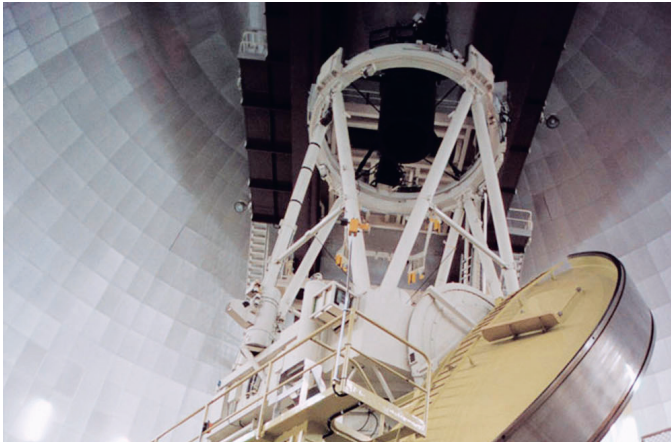

Figure 17 — View of the AAT in its dome showing its massive horseshoe equatorial mount. The drum-like object at the telescope's prime focus is the special spectrograph used for the 2-degree-field Galaxy Redshift Survey, completed in 2002.

Schmidt telescope. Like the latter, the Australian Schmidt was built to compile the Southern Hemisphere complement to the renowned *Palomar Sky Photographic Survey* of the 1950s and 1980s in the Northern Hemisphere.

Commissioned in 1974, the AAT is Australia's largest optical telescope and one of the world's most active. During our visits in 1999 and 2000, it was in the midst of a colossal undertaking, the 2dfGRS, a 2-degree-field Galaxy Redshift Survey, encompassing a 1500-square-degree survey of objects near the south galactic pole. The telescope was equipped with a specially built spectrograph able to obtain simultaneous spectra of some 400 objects. The five-year project obtained nearly 250,000 spectra and photometric measurements of mainly galaxies and quasars down to magnitude 19.5. Among



Figure 18 — Piggyback shot of the core of the Milky Way taken by the author at Siding Spring Observatory in 2000.

other data, the survey provides much information on the local cosmic environment, galaxy distribution and clustering, as well as density parameters on visible and dark matter. It was also the launching pad for several subsequent sky surveys.

For those of us who had not yet seen the spectacular Southern Hemisphere skies, our visits were focused on observing and photographing as much of that as we could fit in. Although weather conditions at Siding Spring are less than ideal, when clear, the seeing and transparency can be unparalleled. When high overhead, the core of the Milky Way was so bright that it cast a shadow (Figure 18). Sadly, in January 2013, fierce brush fires threatened the observatory and several buildings and surrounding homes were destroyed. Fortunately all the telescopes were spared and most are in operation once again.



Figure 19 — The imposing VLT domes of the La Silla Observatory atop Cerro Paranal in Chile, as seen from the visitor centre. Daytime visitors must make advance reservations and are ferried to the top of mountain by buses.





Figure 20 — Three domes of the VLT and two smaller outlying domes are visible in this photo. Note the adjacent vehicles and people for scale.

## La Silla Paranal Observatory

It is no exaggeration to say that Paranal is the most impressive optical observatory in the world (Figure 19). We had the good fortune to visit it during a 2009 expedition to the Atacama region of northern Chile. Our home base was the Atacama Lodge near the historic town of San Pedro. Once again, our goal was to image the marvels of the southern skies, this time using digital cameras instead of film (Brasch 2011). Thanks to very unusual weather and climatic patterns, the area enjoys extremely low humidity and more than 300 clear nights a year. In addition, there is very little artificial light pollution in northern Chile, providing extremely dark, transparent skies. Consequently, several world-class observatories are located there, with Paranal the largest. Operated by the European Southern Observatory (ESO), a consortium of 14 European nations and Brazil, Paranal is a truly massive facility. ESO is also involved in the multi-national ALMA (Atacama

Large Millimetre Array) project and is planning a 40-m class Extremely Large Telescope.

At an elevation of 2635 m atop Cerro Paranal, the ESO's Very Large Telescope (VLT) consists of four individual 8.2-m telescopes, housed in separate domes (Figure 20). Operating at both visible and infrared wavelengths, the four telescopes can work singly or together for interferometry and are supplemented by four movable 1.8-m auxiliary telescopes. Two additional telescopes at the site include the 4-m VISTA and the 2.6-m VLT survey telescope. Due to its remote location, the observatory also has an on-site hotel, housing, shops, and a clinic. In keeping with their multi-national mission, VLT telescopes are involved in a variety of research projects, ranging from direct imaging of exoplanets, to investigating gamma-ray bursts, black holes, and calculating the age of the Universe.

Despite the impressive natural beauty of the Andes, the Atacama Desert, and countless archaeological sites and natural vistas, as well as several great observatories, the most extraordinary experience I took away from the region is its utter “out of this world” feeling. Whether it is the thin air and elevation, the incredibly dark, transparent skies, or the brilliant overarching Milky Way, one comes away with a sense of having travelled to the edge of space (Figure 21). ★

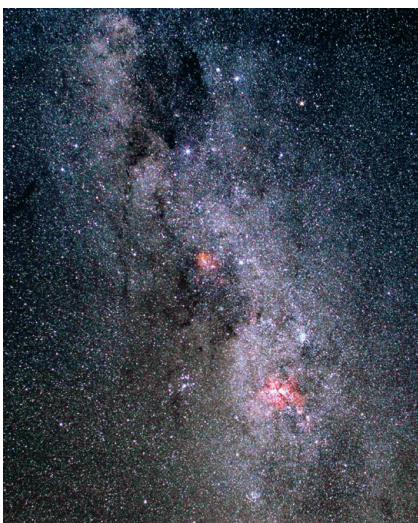

Figure 21 — Some of the jewels of the southern Milky Way, including the Coal Sack, IC 2944, and the Carina Nebula, all shown in this wide-angle image taken by the author in the Atacama region of northern Chile.

## References

- Brasch, K. (2011). Chilean imaging odyssey. *Sky & Telescope*, 122, 72 (October).
- Brasch, K., Viron, T., & Levine, S. (2013). Lowell Observatory and its new Discovery Channel Telescope. *JRASC*, 107, 105.
- Percy, J.R. (2014). Toronto's astronomical heritage. *JRASC*, 108, 83.

Except where otherwise indicated, all photographs were taken by the author.



# An Evening With Neil deGrasse Tyson

by Nicole Mortillaro, Toronto Centre  
(nmortillaro@gmail.com)



Figure 1 – Neil deGrasse Tyson

At the end of 2013, the University of Toronto's Dunlap Institute announced the Inaugural Dunlap Prize. The prize is to be awarded to "recognize an individual whose remarkable achievements resonate with our goals for excellence in astronomy and astrophysics." Its first recipient was none other than the ubiquitous Dr. Neil deGrasse Tyson.

On March 21, Dr. Tyson received the prize and delivered a lecture at the university's Convocation Hall. Tickets to the free lecture were unavailable within seconds, once the registration was opened a few weeks earlier.

About 1500 people attended the lecture—including many RASC members—which was more of an astronomy comedy stand-up routine than straight-up lecture.

When Tyson first took the stage, he acknowledged the contributions of the Dunlap family to astronomy and sang the praises of the David Dunlap Observatory in Richmond Hill, now run by RASC Toronto Centre. Tyson then moved on to none other than Pluto, of course. Many see Tyson as the first nail in Pluto-the-planet's tiny coffin. He redesigned the Hayden Planetarium in 2000 and, instead of including the tiny body in the grouping of planets, sent it off to the icy bodies of the Kuiper belt.

I'm sentimental about Pluto, so I rather enjoyed that I was able to interact with Tyson about it. He asked if there were people in the audience who had a problem with Pluto's "demotion." I was wearing a T-shirt with an image of the Death Star from *Star Wars* blowing up Pluto. Below that were the words, 'Never forget.' I stood up and said that I did, showing him the shirt. He poked fun, the audience laughed and cheered, and, after moving on to his slide that read, "Get Over It," Tyson continued to discuss how others like myself were so passionate about the demotion. He also peppered me with reasons as to why Pluto did not deserve to be a planet ("You realize there are six moons bigger than Pluto?" "You know Pluto's half ice?" "Pluto is among other frozen bodies in the outer Solar System. Now it's one of the biggest among them rather than the puniest planet. I think Pluto's happier.").

Tyson's manner of delivering the lecture provided many laughs. Though he briefly mentioned his books and talked about *Cosmos*, his theme was about global scientific literacy.

He examined the Periodic Table of Elements, eventually breaking it down by country of discovery (the United Kingdom held the top spot, followed by Sweden and Germany).

He also discussed scientific pride on currency around the world and had words of praise for our new \$5 bill, which features the *International Space Station's* Canadarm.

Tyson then showed the audience a map of the world. But this was no ordinary map—the size of the countries was weighted by the per-capita production of peer-reviewed scientific papers. Europe was huge, as was Japan. Canada, well, Canada was almost invisible. But not nearly as invisible as when he showed the audience the same map by the rate at which peer-reviewed research was increasing or declining over time. Why was this? Tyson wondered aloud. Voices echoed throughout the auditorium: "Harper."

Tyson was always a gracious speaker. He interacted with the audience, asked questions, and was sure to address those in the upper balcony. Inclusiveness was very much a part of his talk.

He later ended the lecture by fielding questions from the audience, with topics ranging from scientific literacy to dark matter to genetically modified foods. One of the highlights of the Q&A session was when he poked fun at himself by showing a slow-motion YouTube video of him talking about Isaac Newton as the greatest physicist in history.

Of particular pride to RASC Toronto Centre was when he pulled up the David Dunlap Observatory's Facebook page during the Q&A.

Tyson has the unique ability to make science entertaining and informative. He is a great ambassador for astronomy and a worthy recipient of the Dunlap Institute's inaugural Dunlap Prize. ★

*Nicole Mortillaro is the Associate Editor-in-Chief of the Journal. By day she works as a science and weather reporter for Global News in Toronto.*



Figure 2 – The DDO's Facebook page as it was used during the talk.

# Telescopes in Miniature

by Barry Matthews, Ottawa Centre ([opticks.barry@gmail.com](mailto:opticks.barry@gmail.com))  
with R.A. Rosenfeld, RASC Archivist ([randall.rosenfeld@utoronto.ca](mailto:randall.rosenfeld@utoronto.ca))

## Abstract:

The lead author, who spent decades in the professional restoration of astronomical and other scientific equipment, recounts his recent experience making models of several telescopes important either for their role in astronomical discovery (Herschel), or because of who owned them (Einstein). This is followed by a note on the history and classification of model telescopes.

Here's a question for you: "What does an amateur astronomer owning a backyard observatory do when it's too cold or too overcast to observe, or when his dome won't open due to mechanical gremlins mockingly conspiring with the uncooperative forces of nature?" This is really a classic cloudy-night question, and there are a variety of answers for those who still want to do astronomy. My answer is to retreat to my basement where it is warm and dry, and make scale-model telescopes.

My first such project was a 1:10 scale model of the 7-foot telescope with which William Herschel discovered the planet Uranus on 1781 March 13 (Herschel 1781; Schaffer 1981, 12). This discovery was the very first of a planet using a telescope and for which we know the name of the discoverer!

Of course, the first thing I needed was a good plan, and pictures. Surprisingly, of the approximately 26 surviving in whole or in part Herschel 7-foot telescopes, not one can be

identified as the discovery instrument for Uranus (Maurer 1971, 291; Maurer 1998, 8-13)<sup>1</sup>. The instruments that do survive, along with contemporary iconographic and literary evidence, provide enough data that the characteristics of the Uranus discovery telescope can be surmised with reasonable confidence. And that's good enough for a 1:10 scale-model builder!

On the whole, I prefer not to begin by reinventing the wheel; why not benefit from what has been done before? On the premise that the work that has gone into producing a full-sized (1:1) reconstruction could guide my miniature project, I wrote the Herschel Museum in Bath, who had the full-sized artifact made for their collections in 1980-1981 (Herschel Museum). They were most obliging in putting me in contact with the designer and maker of that telescope, Michael Tabb of the William Herschel Society (Bath), and through his extraordinary generosity and that of the museum, I found myself in possession of copies of his construction notes, detailed plans, and best of all, advice. I was set to go creating piles of sawdust and brass shavings, all in the name of avoiding idleness on cloudy nights.

I imagine I presented the industry of an autumn foraging squirrel (I should know—there are plenty of them causing garden havoc about my Inuksuk Observatory). I worked like crazy cutting, gluing, shaping, turning, and assembling my wonderful model. After all, I had the precedent of Herschel's extraordinary example as recorded by his sister Caroline:

*For my time was so much taken up with...attendance on my Brother [William] when polishing [specula] that by way of keeping him alive I was even obliged to feed him by putting Vitals by bits into his mouth—this was once the case when at the finishing of a 7 feet mirror he had not left his hands from it for 16 hours together (Herschel 2003, 55).*

Well, perhaps I didn't work *quite* that hard. And Cecilia, my understanding spouse, had better things to do than hover over me with victuals (I'm glad to say she spent the time creating fine botanical watercolours).

I was about 85 percent finished when the minor deities of amateur astronomy—doubtless the same forces who amuse themselves by sending in clouds just as we set up our telescopes—chose to intervene! In the brief course of a small Earth tremor, my wonderful creation, the work of countless hours, set in motion by the vibrations, rolled on its finely crafted wheels off the work bench and promptly shattered into many small pieces. I was ready to give up, but as John Brashear was encouraged by his wife Phoebe to start again after his first 30-cm mirror slipped from his grasp and fragmented, Cecilia encouraged me to try again, and to take advantage of the misfortune by using it as an opportunity to do things better the second time (Brashear & Scaife 1925, 51-52). I went back to the drawing board and basement, and managed to create the finished Herschel model illustrated here (Figure 1). Clearly, the sacrifice of the first model was enough to appease the petulant lesser gods of amateur astronomy.

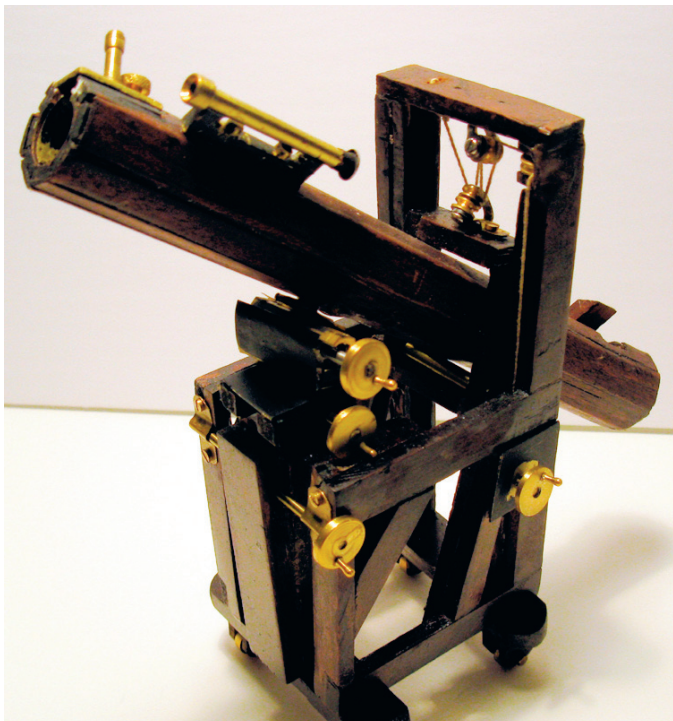

Figure 1 — 1:10 scale model Herschel 7-foot telescope. Copyright Barry Matthews.





Figure 2 — 1:10 scale model of the Einstein Telescope, Hebrew University Jerusalem. Copyright Barry Matthews.

My second cloudy-night essay in miniature telescope creation has as its goal a 1:10 scale model of the Einstein Telescope of Hebrew University in Jerusalem (E. Orion). This is a 20-cm primary mirror, equatorially mounted (manual-drive),  $f/8$  Newtonian reflector. It was made by amateur telescope maker (ATM) Zvi Gezari in a six-month period in 1954 (using a mirror from 1952) as a gift for the great physicist, and presented to him in Princeton (it was restored in 2008). It's an example of one of the standard types of telescope popular among ATMs in the citizen-science movement fostered by Russell W. Porter and Albert Ingalls (this Einstein Telescope is not to be confused with the telescope in the Einstein Tower, Potsdam, a serious and much larger research instrument; Hentschel 1997; UNESCO). Zvi Gezari's Einstein Telescope came to my notice—and that of the worldwide astronomical community—through an article by Eden Orion in the June 2013 issue of *Sky & Telescope* (Orion 2013). Mr. Orion re-discovered the instrument, pieced together its story, and led its restoration. As with my first model, I did the sensible thing and contacted the person at the centre of making an intriguing, old instrument come alive. Mr. Orion generously provided me with many pictures, additional information, and a contact at the Hebrew University. This project is still “a work in progress,” but as unfavourable viewing conditions allow, it too will be finished in time (Figure 2).

After this project is completed I plan to make a model of my own 12.5-cm refractor, and hopefully scale models of scopes owned by fellow amateur astronomers—provided Earth tremors and the whims of tutelary lesser divinities of amateur astronomy don't interfere! I've paid my RASC dues regularly for years, and you'd think Urania would see that I wasn't hassled by her underlings!

## A Note on the History of “Miniature” Telescopes<sup>2</sup>

by R.A. Rosenfeld

The origin of the curious craft of model, or miniature telescope making for sport, profit, or progress has yet to be excavated from the cultural strata of astronomy. Among the voluminous and accessible literature on astronomy in English there appears to be no papers or monographs on the emergence, production, use, or

curation of models of astronomical apparatus. This brief note, whatever its shortcomings, is a tiny step towards that history.

What, then, is a miniature or model telescope? The question might seem so obvious as to be hardly worth the asking. The Oxford English Dictionary offers among its definitions of “miniature” and “model” the following:

*miniature, n. and adj...*A. n. I. *Something that is a smaller or reduced version of an original, and related senses.* 1. a. *A likeness or representation on a small scale; a small-scale model; (occas.) a minutely finished production (OED miniature).*

*model, n. and adj...*2. *That is a model or representation of something else, esp. on a small scale; esp. designating a miniature reproduction of a building, machine, vehicle, etc., constructed for pleasure, as model aeroplane, model railway, etc. (OED model).*

Based on these current definitions, “miniature” and “model” can be used interchangeably, and the redundancy of the question is in turn confirmed—until one asks the further question “how old is the synonymous usage? Surprisingly, that query cannot be answered from the OED entries, for while “model” figures within the highly ranked definition for “miniature,” and vice versa, no citations directly attesting to those definitions are provided! Our present synonymous use of “miniature telescope” and “model telescope” may be no earlier than the last century.

A further problem of definition arises from the variety of the models themselves; are miniature telescopes a single genre of object, or two, or three? Should the fully working miniaturized telescope designed for portability, or to meet tight space and weight requirements, or to display a maker's virtuosity, be considered the same sort of object as the non-working model? Besides imperatives of design and application, another consideration is size; does it matter? Is a Barry Crist miniature of a C-8, which can easily fit in a child's hand and is meant solely for display, the same sort of object as the 1:10 scale fully working engineering model of the Hale 200-inch (built 1935), now at the Eileen Collins Observatory (RaineyDayScience; Palomar Skies<sup>3</sup>)? The latter was commissioned as an engineering prototype for serious technical and scientific reasons, perhaps analogous to Russell W. Porter's famous cut-away drawings of the Hale Telescope, yet it undeniably functions—and probably always did—as an *imago*, an icon of the full-sized telescope (Fassero & Porter 1952). It takes some mental adjustment to think of a fully functioning telescope with a 50.8-cm (20-inch) primary mirror as a “miniature,” yet this model *is* a miniaturized version of the Hale Telescope, if a rather imposing one.

A comparable case to the Eileen Collins Observatory's Hale model is the University of St. Andrew's Scott-Lang Telescope, a 45.72-cm (18-inch) “half-scale pilot model” (completed 1951) for the 93.98-cm (37-inch) James Gregory Schmidt (1960)

(Finlay-Freundlich & Waland 1953). For a model that primarily functions as an engineering prototype, size is not the determining factor that representative functionality and operability are. At a meeting of the Royal Astronomical Society in 1886, Howard Grubb exhibited a working, scale model of his invited design for the Lick dome; it was certainly not 1:2 and probably not even 1:10 scale, but its operation showed that Grubb's design concepts were likely viable (Anon. 1886).

A smaller, working example than the Eileen Collins Observatory's Hale and the St. Andrew's Scott-Lang Telescope, but that nonetheless demonstrates that "monumentality" needn't depend on scale or sheer size, is the impressive Perkins Telescope Model, now in the collection of the Smithsonian's National Air and Space Museum (Smithsonian Institution Collections, inventory number: A19820361000). According to an unconfirmed provenance, the instrument was constructed between 1913 and 1915 and was used as a prop to raise funds for what eventually became the Perkins 69-inch telescope of Ohio Wesleyan University (1931). The working model has an 11.43-cm (4.5-inch) primary.

Among surviving working "miniaturized" telescopes designed for portability and the display of craft virtuosity are some late Georgian and early Victorian refractors. In the Josef Pieter Zallinger Collection at the National Maritime Museum, Greenwich, is a late-18th-century Dollond single-drawtube achromatic refractor on a library stand, with a 9.8cm x 2.54cm OTA (Royal Museum Greenwich, object ID: AST0933). This quality instrument is interesting, because it features an early type of rotating eyepiece—actually an integral wheel that can move any of four different eyepieces into the optical train (it is not the only such artifact in the collection). A similar instrument is in the Collection of Historical Scientific Instruments, Harvard University (inventory number: 5003), signed Gilbert, Tower Hill, London, and dated 1760-1780 (Waywiser). More complex, but on some level conceptually related, is a fully operational miniature altazimuth instrument by Robinson, dated ca. 1830, at the Museum of the History of Science, Oxford University (inventory number: 47389; MHS Collection Database). Also to be included here are John Browning's miniature spectroscopes from the second half of the 19th century (Browning 1869). There is an element of show to these instruments, but they could also have been used to actually observe the heavens. They are not too far from the telescope Mary Ward used for her own observations, when she executed her memorable astronomical drawings (Brück 2009, 93-98). Mary Ward in turn wrote for those with "a good telescope, but with an object-glass only two inches in diameter, *or even less*" (Ward 1879, 1, italics ours). "Even less" would encompass achromats with objectives of 2.54-cm. It should be observed that the perception that these instruments are "miniature" may be a largely modern one; they may have been considered at the time of their manufacture to be at the lower end of the *normal* range of aperture. The adjective one finds in the trade literature of the day is "pocket," rather than "miniature," although more often than not telescopes bear no descriptive qualifier of size

other than a neutral figure for OTA length, in contrast to the frequent use of "pocket" to describe small microscopes (*e.g.* Jones *ca.* 1784, 3; Adams *ca.* 1765, 12-13).

Miniature OTAs can be found in modern professional astronomical applications. One early example is the Paraskévopoulos' attempt to measure the integrated magnitude of the 47 Tucanae cluster, using a miniature photographic telescope of 2.54-cm aperture and 2.54-cm focal length ( $f/1!$ ; Paraskévopoulos 1925). In the early 1950s, Finsen used an apparatus incorporating "a miniature telescope with object glass of 12.5-mm focal length and eyepiece of 10-mm focal length" in lab experiments to interferometrically measure artificial double stars (Finsen 1951, 413-415). A more recent example is the solar scintillometer developed by Gupta and colleagues, which was attached to the SPAR telescope at the Udaipur Solar Observatory to aid in quantifying the seeing in order to characterize the site for the proposed MAST (Multi Application Solar Telescope):

*The scintillometer consists of a miniature telescope, termed a micro telescope (4mm aperture, 15mm focal length) mounted on a drive which tracks the Sun continuously, associated amplifiers and a data acquisition system. A photodiode is used as the detector. The telescope along with detector was obtained from National Solar Observatory (NSO), and is similar to the one used for [the] Advanced Technology Solar Telescope (ATST) site survey (Gupta et al. 2006, 315).*

Project advocacy and fund raising are ends that have frequently called forth the creation of telescope and observatory models. It is more usual for such models to be non-working, which makes the Perkins Telescope Model exceptional in that regard (if fund raising was indeed its function). Non-working models are generally easier and less expensive to build. They are analogous to the maquettes used to further architectural and civic engineering projects. Non-working models of the Otto Struve Telescope, Yale-Columbia 26-inch astrometric refractor (Schlesinger's Telescope), the Shane Telescope, its dome (skeletonized), and a 1:1 "mock-up" of its observing cage, the United States Naval Observatory Flagstaff Station (NOFS) 1.55-m Kaj Strand Astrometric Reflector, the 1-m Askania Cassegrain-coude for the Cagigal Observatory, the Stratoscope II telescope, the domeless solar refractor of the Capri Observatory, the Mayall 4-m Telescope, and the 150-foot radio telescope at the US Navy Information Operations Command Sugar Grove Naval Station have all functioned as project maquettes, and there are many more (Burrell 1933, 20-22 ; Federer 1944; Wallace 1950, 292; Federer 1960; Inglis 1961, 252; Federer 1961; Federer 1964, 272; Crawford 1965, cover, 272; Federer 1965).

Physical, three-dimensional maquettes have not become obsolete in the world of big science, to be replaced by CAD or virtual reality models (although the latter have arguably become much



more important and crucial in project design and development). Current models of upcoming next-generation telescopes and installations are often employed as props to secure stages of project approval, as were their predecessors. This is not a function of model telescopes that is likely to grow old.

The remaining use of miniature telescopes is in education and public outreach (many readers may think this the most obvious of applications). Observatories of any size or importance that admit the public on occasion frequently possess models of their own equipment, and that of other significant observatories. An amateur in 1912 noted on his visit to the Mount Wilson Solar Observatory that:

*The observatory museum, which is open to the public, contains many interesting and remarkable photographs nearly all of which were made with the instruments here. Perhaps the photographs attracting special attention are two of the 100-inch telescope model, which was designed and constructed in the observatory shops and sent to Washington, D.C. (Lanham 1912, 529-530).*

He then devotes the majority of his communication to describing features of the Hooker telescope based on the photographs of the model (first light for the Hooker came five years later). Another, later model of the Hooker Telescope was on exhibit at the Hayden Planetarium in New York City (Faunce 1944, 6). When the Adler Planetarium & Astronomy Museum opened in 1930, one of its indoor exhibits was a large working-model observatory, complete with telescope, based on the United States Naval Observatory in Washington D.C., with its 26-inch “Great Equatorial” by Alvin Clark (Fox 1933, 33 pl. 29, 58). The amateur C.E. Raible made two models of the Hale telescope, one a display model, and the other a full-working 1:16 scale model with a 31.75-cm primary “complete in every detail,” which was displayed at the Buhl Planetarium in Pittsburgh (Federer 1940b-c). In the historic collections of the Department of Astronomy and Astrophysics of the University of Toronto are four table-top models of painted wood, representing the Hale 200-inch, the Hooker 100-inch, and the David Dunlap Observatory (DDO) 74-inch reflectors, and the Lowell Observatory 24-inch refractor. These models appear to date from the first couple of decades of the DDO’s existence, and were produced in the observatory’s shops. The models were on display in the administration building when the public visited and may have been used in basic undergraduate teaching to illustrate the difference between types of equatorial mounting. Presently on display in the reception area of the Department of Astronomy & Astrophysics at the University of Toronto is a beautifully executed professionally made model of the Thirty-Metre Telescope belonging to Professor Ray Carlberg (Project Director, TMT-Canada). It can be considered a worthy descendant of the project promotion and didactic models listed above.

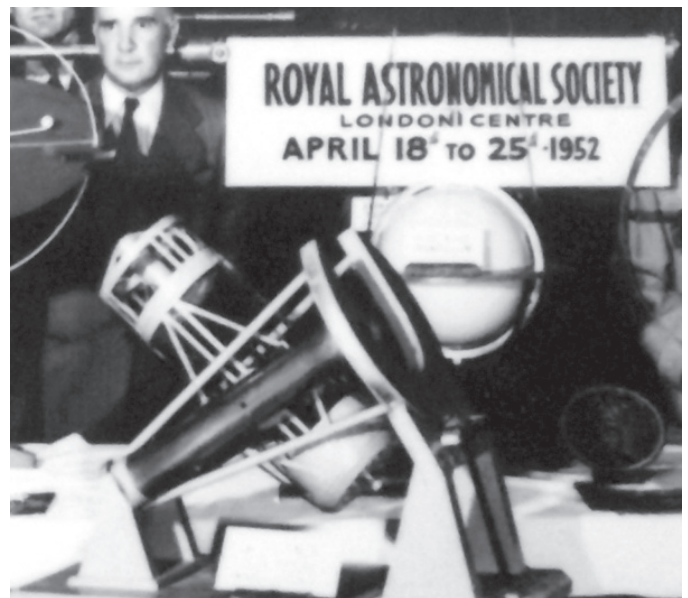
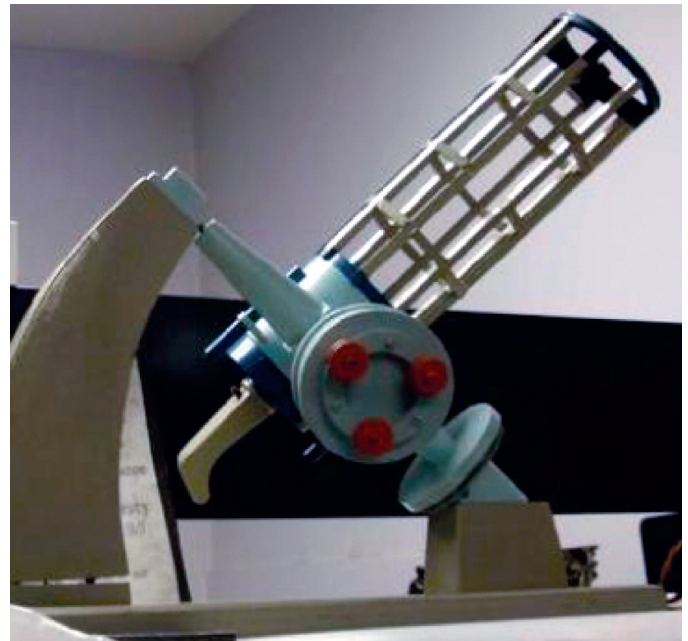

Figure 3 – 1940s-1950s (?) model of the David Dunlap Observatory 74-inch. Reproduced courtesy of the Dunlap Institute for Astronomy & Astrophysics. (top)

Figure 4 – Model of the Hale Telescope on display at a London Centre event, 1952 April 18-25.

One must not omit mention of models of space observatories and probes, which have in recent decades been made available for education, advocacy, and entertainment by space agencies and others. These are designed for execution in paper and more permanent media (HubbleSite; James Webb Space Telescope; Canadian Space Agency). Prior to this initiative by the space agencies themselves, and before the advent of space telescopes, wholly commercial enterprises marketed models of probes and manned-mission vehicles from nearly the commencement of the space age.

*Continues on page 118*



*Figure 1 — "... a gorgeous nebula complex that really does not get the attention it deserves" observes Klaus Brash, who provided the Journal with this commanding image of the Christmas Tree Nebula (a.k.a. the Cone Nebula) in Monoceros. The "Christmas Tree" almost disappears in the extensive surrounding nebulosity that includes NGCs 2247 and 2254. The image is a mosaic of six taken with a TMB-92 refractor and a Canon 6D. Total exposure was 20 minutes at ISO 3200 and 6400.*



*Figure 2 — Rodney Dingman caught the well-known galaxy M81 image from Elkhorn, Manitoba, using a 12-inch Astrotech telescope and an SBIG 8300 camera. Exposure was 10×900 s in L, 10×600 s in RGB, and 8×900 s in H $\alpha$ . M81 lies about 12 Mly distant in Ursa Major and is one of the closest galaxy clusters to our own Local Group.*





Figure 3 — John D. McDonald provides us with another scene from the All-Star Party at the Painted Pony Resort in New Mexico, this time of Venus rising after the Milky Way. John notes, “This one was of modest duration. It was long enough to give a sharp and low-noise sky but short enough to minimize a blurred foreground from the tracking mount’s motion.” He used a modified Canon 6D for a 52-second exposure at ISO 3200 with a 24 to 105-mm lens operating at 24-mm focal length.



Figure 4 — Ever since the Hubble Space Telescope made the “Pillars of Creation” an iconic image of space photography, the Eagle Nebula has been a favourite of astrophotographers. The Eagle lies at a distance of 6500 ly in the constellation Serpens, illuminated by the hot, bright stars of the cluster M16, seen in the top of this image from Steve Holmes. The bright edges surrounding the filaments in the image are sites where ultraviolet radiation from hot, new stars is burning away and pushing back the dense gas and dust.



A working classification of telescope models/miniatures can be proposed:

- 1a: non-working approximate representation (*i.e.* lacks functional optical and mechanical components);
- 1b: non-working accurate representation (*i.e.* lacks functional optical and mechanical components);
- 2a: working approximate representation (*i.e.* includes functional optical and mechanical components);
- 2b: working accurate representation (*i.e.* includes functional optical and mechanical components)

These types are all subject to variation in scale, and medium. The current usage as remarked is for “miniature” and “model” to be used as synonyms, but not all models need be miniatures. Models of types 1a-b, or 2a at 1:1, or 2:1, for instance are possible. And, not all miniatures need be models of specific telescopes, or even classes of telescopes (as is evident for the 18th- and 19th-century examples cited above).

A subsidiary classification according to function can also be proposed:

- I. decoration;
- II. icon *i.e.* a symbol);
- III. fund-raising and promotional prop;
- IV. didactic tool;
- V. engineering tool (*i.e.* a model used to characterize the performance of the whole design or a part through experimentation);
- VI. scientific tool (*i.e.* a model that is a fully functioning scientific apparatus in its own right capable of collecting the same type of scientific data as the full-sized instrument).

As a working hypothesis, the origin of model or miniature telescopes, associated apparatus, and structures—representations of larger “full-sized” equipment—might be placed no later than the Victorian period, and the practice may possibly extend back to the late-Georgian era in the English-speaking world. The ends for which models were first made were probably various, the testing of engineering coherence and feasibility being one, but formal and informal education and pure entertainment may also have been early motives. In regard to the last, it is not inconceivable that the techniques for making ship’s models, architectural models, stationary steam-engine models, and early train models influenced the making of miniature telescopes, and one suspects those who indulged in the former pursuits may also have been amateur astronomers.

The present writer can attest that models of astronomical equipment exercise an indefinable fascination wholly transcending their instrumental use in education; this, after all, is why they are employed in selling big science to those who can

make big science happen. It’s certainly what makes such a comparatively little thing big in potential, be it a miniature hand-held telescope, or a tabletop model observatory, or even a working-model telescope with a 50.8-cm primary mirror. It’s doubtless why models work as icons evoking instruments that were, are, and may yet come to be.

## Acknowledgements

The authors would like to thank Lee Robbins, Librarian of the Department of Astronomy and Astrophysics of the University of Toronto, and Professor Peter Martin, Interim Director of the Dunlap Institute for Astronomy & Astrophysics, for permission to publish the image of the model of the DDO reflector from the Dunlap Institute’s collections. We also wish to acknowledge advice from Professor Emeritus Ernie Seaquist. We are grateful to Peter Abrahams of the Antique Telescope Society for useful suggestions. This research has made use of NASA’s Astrophysics Data System. Any errors remaining are the authors’ sole responsibility”

## (Endnotes)

1. Two candidate instruments are the 7-ft reflector still in the possession of the Herschel Family, and the comparable instrument in the collections of the Science Museum, London, inventory number: L2009-4029 (Maurer 1971, A-5, B-11; Maurer 1998, A-5, B-11; Science Museum).
2. In this paper, telescopes are referred to by their current names of dedication, and not by their names when first commissioned.
3. The engineering model of the Hale Telescope is actively used for science and EPO in a community college observatory, and, fittingly, was the instrument of discovery for minor planet 34419 Corning (2000 SA7) (JPL Small-Body Database Browser). More models of the Hale telescope—professional engineering models, planetarium display models, private amateur display models, and commercial models—were probably produced in the 20th century than of any other telescope (*e.g.*, Hayden Planetarium 1936; Federer 1940a-c; Copeland 1946, 5; Scanlon 1947; Back 1948, 247; Hubbard 1948; Scholz 1949; McAllister 1952; Lafayette Radio 1956). The most striking model was probably the non-commercial, highly-finished one produced by Westinghouse out of celluloid. The version sold by Lafayette was marketed as having “working Bausch & Lomb optics,” and as “just the thing for space minded children.” McAllister was from Rossland B.C., and his model received awards when exhibited in that province. In the early 21st century, the distinction of “telescope most often modelled” probably belongs to the *Hubble Space Telescope*”

## References

### Manuscripts, Books, and Articles

- Adams, G. (ca. 1765). *A Catalogue of Optical, Philosophical, and Mathematical Instruments*. London: n.p.
- Anon. (1886). Royal Astronomical Society, *English Mechanic and World of Science* 43, 1104, 252
- Back, M. (1948). Astronomical League Convenes at Milwaukee, *Sky & Telescope* 7, 10, 247-248



- Brashear, J.A. & Scaife, L. (1925). *John A. Brashear: the Autobiography of a Man who Loved the Stars*. Boston: Houghton Mifflin
- Browning, J. (1869). The Miniature Spectroscope, *English Mechanic and Mirror of Science* 9, 217, II
- Brück, M. (2009). *Women in Early British and Irish Astronomy: Stars and Satellites*. Dordrecht Heidelberg London New York: Springer
- Burrell, E.P. (1933). New Observatory to be Built with 80-Inch Telescope, *The Telescope*, ser. 2, 2, 19-22
- Copeland, L.S. (1946). The Eye That Will Look for the Uttermost, *Sky & Telescope* 5, 4, 3-6
- Crawford, D.L. (1965). The Kitt Peak 150-Inch Telescope, *Sky & Telescope* 29, 5, 268-273
- Fassero, J.S. & Porter, R.W. (1952). *Photographic Giants of Palomar*. Los Angeles: Westernlore Press
- Faunce, W.M. (1944). Interpreter of the Heavens, *Sky & Telescope* 3, 2, 5-7
- Federer, C.A. (1940a). Perkins Observatory is Host to the American Astronomical Society, *The Sky: Magazine of Cosmic News* 4, 4, 3-4
- Federer, C.A. (1940b). Amateur Astronomers Association, *The Sky: Magazine of Cosmic News* 4, 7, 18
- Federer, C.A. (1940c). Amateur Astronomers Association, *The Sky: Magazine of Cosmic News* 4, 8, 14
- Federer, C.A. (1944). Amateur Astronomers, *Sky & Telescope* 3, 6, 10
- Federer, C.A. (1960). American Astronomers Report, *Sky & Telescope* 20, 6, 334-335
- Federer, C.A. (1961). News Notes: Stratoscope II, *Sky & Telescope* 22, 3, 152
- Federer, C.A. (1964). Exhibit Notes from Hamburg, *Sky & Telescope* 28, 5, 272-273
- Federer, C.A. (1965). 150-Foot Radio Telescope at Sugar Grove, *Sky & Telescope* 29, 6, 346
- Finlay-Freundlich, E. & Waland, R.L. (1953). A New Telescope in Scotland, *Sky & Telescope* 12, 7, 176-177
- Finsen, W.S. (1951). Double Star Interferometry, *Popular Astronomy* 59, 8, 399-418
- Fox, P. (1933). *Adler Planetarium and Astronomical Museum. An Account of the Optical Planetarium and a Brief Guide to the Museum*. Chicago: The Lakeside Press, R.R. Donnelly & Sons Co.
- Gupta, S.K., Mathew, S.K., & Venkatakrisnan. P. (2006). Development of Solar Scintillometer, *Journal of Astrophysics and Astronomy* 27, 315-320
- Hentschel, K. (1997). Hentschel, A. (Tr.), *The Einstein Tower: an Intertexture of Dynamic Construction, Relativity Theory, and Astronomy*. Stanford CA: Stanford University Press
- Herschel, C. (2003). Hoskin, M. (Ed.), *Caroline Herschel's Autobiographies*. Cambridge: Science History Publications
- Herschel, W. (1781). Account of a Comet, *Philosophical Transactions of the Royal Society of London* 71, 492-501
- Hubbard, S.E. (1948). Advertisement for 200" Telescope 10"-High Scale Model, *Sky & Telescope* 7, 10, 254
- Inglis, S.J. (1961). Astronomy in Venezuela, *Sky & Telescope* 22, 5, 252-253
- Jones, J. (ca. 1784). *A Catalogue of Optical, Mathematical, and Philosophical Instruments*. London: n.p.
- Lafayette Radio (1956). Working Scale Model of Mt. Palomar Giant Telescope, *Sky & Telescope* 15, 11, 513
- Lanham, G. (1912). A Visit to the Mount Wilson Solar Observatory, *Popular Astronomy* 20, 528-530
- Maurer, A. (1971). William Herschel's Astronomical Telescopes, *JBAA* 81, 284-291
- Maurer, A. (1998). A Compendium of All Known William Herschel Telescopes, *Journal of the Antique Telescope Society*, 14, 4-15
- McAllister, R.D. (1952). Astronomy for Fun, *Sky & Telescope* 11, 4, 85
- Orion, E. (2013). The Story of Einstein's Telescope, *Sky & Telescope* 125, 6, 32-36
- Paraskévopoulos, J.S. (1925). Integrated Magnitude of 47 Tucanae, *Popular Astronomy* 33, 625
- Scanlon, L.J. (1947). A Scale Model of the 200-Inch Telescope, *Sky & Telescope* 7, 1, cover, 3-4
- Schaffer, S. (1981). Uranus and the Establishment of Herschel's Astronomy, *Journal for the History of Astronomy* 12, 11-26
- Scholz, G.C. (1949). The Story of Palomar in Color and Sound, *Sky & Telescope* 8, 4, 94
- Wallace, H.A. (1950). Western Amateur's Convention, *Sky & Telescope* 9, 12, 291-292
- Ward, M. (1879). *The Telescope: a Familiar Sketch, Combining a Special Notice of Objects Coming Within Range of a Small Telescope...5th ed.* London: Goombridge

## Web sites

- Canadian Space Agency, Alouette Model  
[www.asc-csa.gc.ca/pdf/alouette-model.pdf](http://www.asc-csa.gc.ca/pdf/alouette-model.pdf) (accessed March 25)
- Herschel Museum, Telescopes  
<http://herschelmuseum.org.uk/explore/telescopes/> (accessed 2014 March 18)
- E. Orion, Einstein Telescope Restoration  
[http://edenorion.com/wp\\_home/?p=119](http://edenorion.com/wp_home/?p=119) (accessed 2014 March 18)
- HubbleSite, Hand-Held Hubble  
[http://hubblesite.org/the\\_telescope/hand-held\\_hubble/](http://hubblesite.org/the_telescope/hand-held_hubble/) (accessed 2014 March 25)
- James Webb Space Telescope, Paper model  
<http://jwst.nasa.gov/papermodel.html> (accessed 2014 March 25)
- JPL Small-Body Database Browser, 34419 Corning (2000 SA7)  
<http://ssd.jpl.nasa.gov/sbdb.cgi?sstr=34419> (accessed 2014 March 19)
- MHS Collection Database, Miniature Altazimuth Instrument, by Robinson, London, c. 1830  
[www.mhs.ox.ac.uk/collections/imu-search-page/record-details/?thumbnails=on&cirn=3295&TitInventoryNo=47389](http://www.mhs.ox.ac.uk/collections/imu-search-page/record-details/?thumbnails=on&cirn=3295&TitInventoryNo=47389) (accessed 2014 March 20)
- OED, miniature  
[www.oed.com.myaccess.library.utoronto.ca/view/Entry/118826?rskey=vhlqe1&result=1#eid](http://www.oed.com.myaccess.library.utoronto.ca/view/Entry/118826?rskey=vhlqe1&result=1#eid) (accessed 2014 March 25)
- OED, model  
[www.oed.com.myaccess.library.utoronto.ca/view/Entry/120577?rskey=CPoinv&result=1#eid](http://www.oed.com.myaccess.library.utoronto.ca/view/Entry/120577?rskey=CPoinv&result=1#eid) (accessed 2014 March 25)
- Palomar Skies, Kardel, Hale Prototype  
<http://palomarskies.blogspot.ca/2009/05/hale-prototype.html> (accessed 2014 March 19)
- RainyDayScience, Barry Crist  
<http://tinyurl.com/knfn79r> (accessed 2014 March 19)
- Royal Museum Greenwich, Miniature Refractor Telescope  
<http://collections.rmg.co.uk/collections/objects/11095.html> (accessed 2014 March 19)
- Science Museum, Seven-foot Telescope Made by William Herschel  
<http://tinyurl.com/ks9jstn> (accessed 2014 March 18)
- Smithsonian Institution Collections, Model, Reflecting Telescope (Perkins Telescope Model)  
[http://collections.si.edu/search/record/nasm\\_A19820361000](http://collections.si.edu/search/record/nasm_A19820361000) (accessed 2014 March 19)
- UNESCO, The Einstein Tower, Potsdam, Germany  
<http://www2.astronomicalheritage.net/index.php/show-entity?identity=38&idsubentity=1> (accessed 2014 March 18)
- Waywiser, Miniature Telescope  
<http://tinyurl.com/pvvr6h> (accessed 2014 March 20)

# Cosmic Contemplations

## Build Your Own Thermal-Electrically Cooled True Monochrome DSLR For Less Than \$300!



by Jim Chung, Toronto Centre  
(jim\_chung@sunshine.net)

A year ago, I was converting about a dozen current-model Nikon DSLRs to monochrome sensing for people from all over the world. I stopped doing it because I felt obligated to financially absorb the occasional failures, and I was also concerned about the reduced lifespan of the now-opened and exposed CMOS sensor. Japan experienced a rash of sensor failures in 2005 in a wide variety of consumer products, and it was traced to the use of weaker epoxy-based circuit packaging (rather than traditional ceramic), allowing moisture to seep into the chip cavity. Others have now carried the ball further downfield and have successfully converted Canon DSLRs by physically stripping away the microlens and Bayer layer with just a simple bamboo chopstick! Aside from the fact that it takes somewhere between 3 to 4 hours to strip each sensor, the sensor no longer has an intact microlens layer and still needs to be resealed in a vacuum or nitrogen-purged chamber.

There had to be a better way, because I still lusted after the Leica M Monochrom DSLR and wanted a fully functional camera to take true high-contrast black-and-white terrestrial images and the occasional astro image.

Olympus introduced their new Evolt 500 DSLR in 2005, selling it in Canada with a kit lens for the substantial price of \$1500. Unfortunately the camera was then eclipsed by the Canon 20D, which had been introduced just a year earlier and had become the amateur astronomer's instrument of choice owing to the low-noise performance of its CMOS sensor. What is of interest is that the Olympus uses the 8-megapixel Kodak KAF-8300CE CCD sensor that also comes in monochrome form. The KAF-8300AXC chip is widely used in many different dedicated astroimaging cameras such as those from SBIG, QSI, FLI, Celestron, and Orion, to name just a few. The KAF-8300 is also an older-style chip with DIP (dual in-line pin) packaging, meaning that the chip is soldered to a conventional circuit board rather than as a surface-mounted component. Theoretically, anybody with a steady soldering iron can perform a little electronic surgery and transplant a monochrome 8300 chip for the original colour one and make a *true* monochrome DSLR.

Figure 3 — The Abbe refractometer.

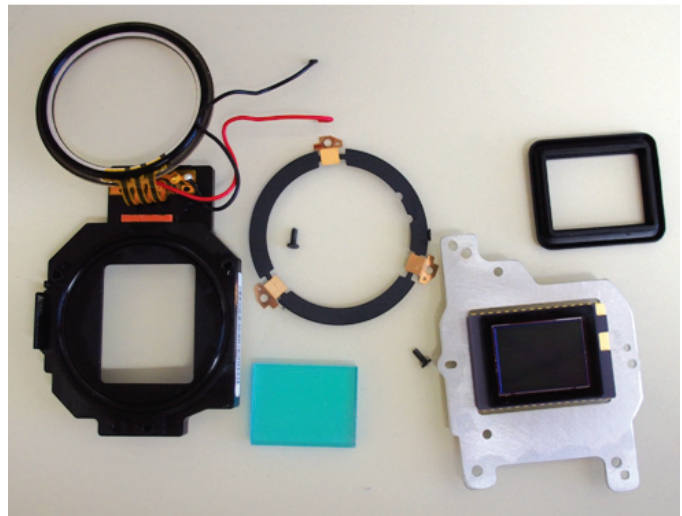

Figure 1 — The disassembled sensor components of the E-500.



Figure 2 — The gear puller, aluminum board, and sensor chip.



E-500 bodies can be found on eBay for around \$100 and disassembly is not particularly difficult, but some of the free flexible cables (FFC) are short, and care must be taken to prevent damaging their ZIF sockets. The KAF-8300 sensors are sold by *Trusense Imaging Inc.* of Rochester, New York, and can be had for as little as \$100 for engineering-grade chips with AR coatings and a microlens layer. Engineering-grade chips may come with dead pixels and cosmetic blemishes to the chip casing. Standard-grade



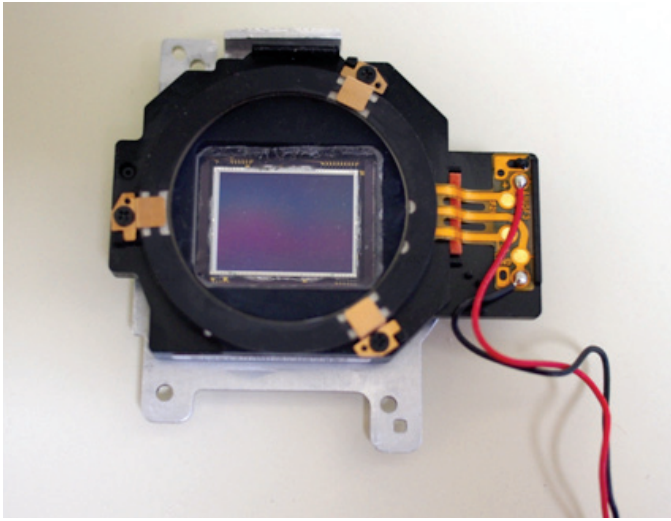

Figure 4 — The sensor assembly with the monochrome chip installed.



Figure 5 — Before-and-after test exposures. Notice the change in  $f$ -ratio from 5.6 to 13.

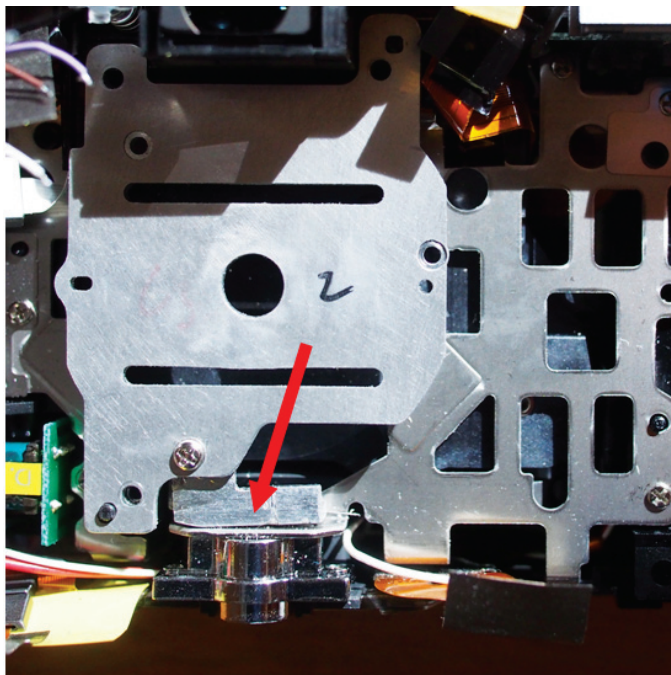

Figure 6 — The L-shaped aluminum insert that gives a thermal path between the tripod circuit and the sensor base.

chips are \$425 apiece. My experience showed that there were no discernable differences between the image qualities of the engineering- and standard-grade chips.

A small gear puller is useful to separate the chip, which is glued to the aluminum board. Make sure the aluminum board remains flat and is not warped after this procedure and all trace of adhesive is removed down to bare metal, as this will affect alignment of the focal plane of the new chip.

The aquamarine-coloured IR blocking filter and anti-aliasing blur filter is a multilayered glass element that must be removed and replaced with glass of known thickness and refractive index to maintain accurate autofocus capability of the camera. The refractive index of various glass samples was determined by using an Abbe refractometer and a high-refractive-index carrier liquid, 1-bromonaphthalene. The refractometer was another eBay purchase, a wonderful prewar instrument made by the *Spencer Lens Company* of Buffalo, New York. Charles Spencer made the very first achromatic doublet refractor in America at age 12 and a compound microscope by age 16. He formed his company in 1838, selling and manufacturing 3- to 10-inch reflectors and 1- to 3-inch refractors. By 1850, he was renowned for producing the world's best microscope objectives.

I sourced optical window glass of similar OEM thickness and size from Edmund Optics, Surplus Shed, and Omega Optics (eBay). I used equation 1 to determine focal shift as a result of the optical window (ow):

$$\text{focal shift} = (n_{ow} - 1)/(n_{ow}) \times \text{ow thickness} \quad (1)$$

Glass Source	Refractive Index @ 22 C	Thickness (mm)	Focal Shift (mm)	Shim Thickness to subtract (mm)
Olympus	1.510	3.30	1.115	0.00
Omega Optics	1.517	3.00	1.022	0.09
Edmunds	1.465	3.10	0.984	0.13
Surplus Shed	1.517	3.70	1.261	-0.15

The camera comes with two shims, 0.1 and 0.25 mm in thickness. By deleting the thinner shim and bringing the sensor chip a little closer to the lens flange, I was able to use the Edmund glass to preserve autofocus. Lastly, the Edmund glass was cut on one side to fit the enclosure, which also houses the ultrasonic dust shaker.

The camera produces sharper images with light-sensitivity increase of at least 2.5 full  $f$ -stops.

The second modification addresses the fact that the 8300 chip is rather noisy. With long exposures, thermal dark noise builds quite readily. I was inclined to thermoelectrically cool the chip via a Peltier semiconductor component but keep the

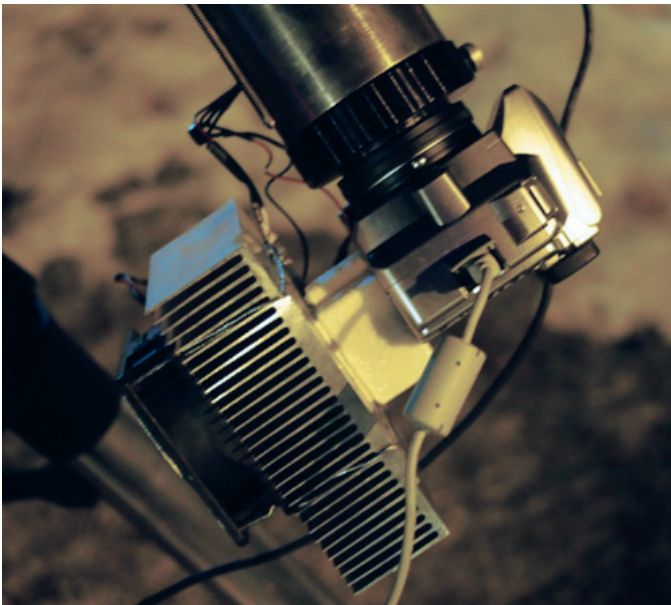

Figure 7 – The thermoelectric cooler attached to the camera.

camera looking completely stock. Luckily, the chip already straddled a piece of aluminum, so if I could somehow cool that piece of metal, I could cool the chip. There was just enough room to add a small piece of angle aluminum to connect the sensor assembly to the tripod screw hole at the bottom of the camera. A TEC unit liberated from a 12VDC car cooler with a computer cooling fan had a 1/4×20 tripod bolt tapped into the “cold” side heatsink and attached to the camera completing the cooling circuit.

I did not expect good cooling efficiency because of the roundabout fashion of directing the cooling to the 8300 chip, but dark-frame tests did show significant differences.

Finally, an example of astroimaging with the modified E-500 is shown in Figure 10. The strange artifact in the upper left-hand corner is likely noise known as “amp glow,” that is,

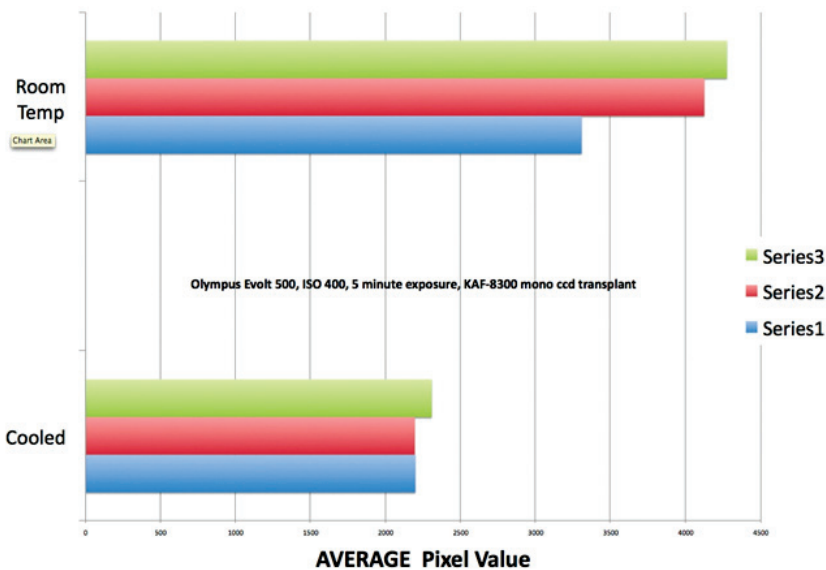
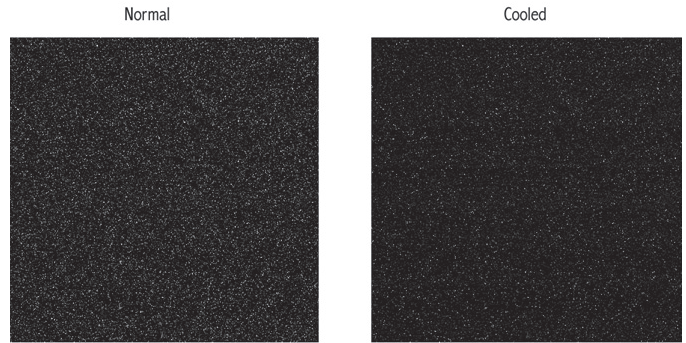
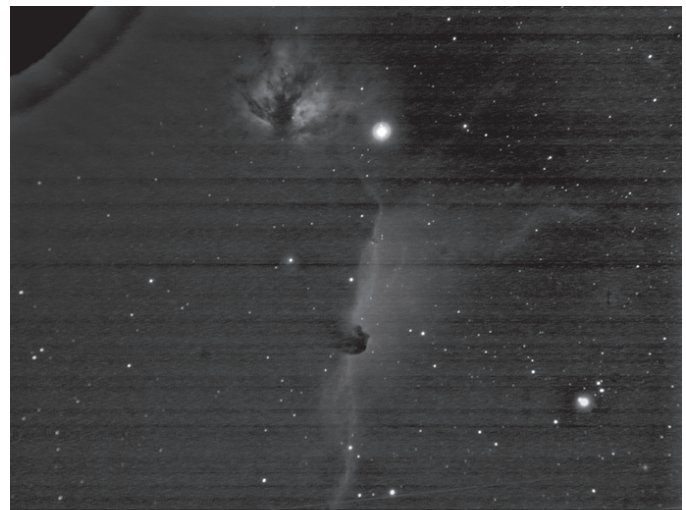

Figure 8 – Hot pixel counts before and after cooling the sensor.



lower right hand corner of 5 minute DARK frame (400x400 pixels)

Figure 9 – Five-minute dark frames comparing the number of hot pixels with and without cooling.



Horsehead Nebula. Evolt-500 ISO 400 10x8 minute exposures with mono KAF-8300, AP Traveler

Figure 10 – The Horsehead Nebula captured in ten 8-minute exposures using the modified monochrome camera.

thermal noise from closely packed ancillary electronics. This was a common problem in the Canon 20D as well, and frankly, those cameras were never designed to take long-exposure astronomical images! The horizontal banding noise is something I have experienced in newer Olympus micro 4/3rds cameras, although to a lesser degree, and the current models have their sensors made by Sony and are as clean as anything from Canon. \*

*Jim Chung has degrees in biochemistry and dentistry and has developed a particular interest for astrophotography over the past four years. He is also an avid rider and restorer of vintage motorcycles, which conveniently parlayed into ATM (amateur telescope maker) projects. His dream is to spend a month imaging in New Mexico away from the demands of work and family.*



# Rising Stars

## Thanks to the Unknown Soldiers of Astronomy



by John Crossen  
([johnstargazer@xplornet.com](mailto:johnstargazer@xplornet.com).)

In every astronomy club there are a few members who seem to do all the work. They're always there for public observing sessions. When it comes to doing presentations to the other members, you can count on them to come up with something of interest. On Astronomy Day, they're at the ready with prizes, presentations, and telescopes for both solar and nighttime observing. Some take their stands at the booths and displays, while others explain the different kinds of telescopes on hand.

Chances are they often wonder why they and a few other members are the only ones who seem to care—and rightly so. A friend of mine once said that in any club, 80 percent are subscribers and the rest are “doers.”

That holds true for our club. With 57 members, we have about 10 who are actively engaged in our activities. If you're one of the “doers” in your club, this is an open thank you. Without you, amateur astronomy would wither like a fist full of geraniums in the Atacama Desert.

I have singled out three of my fellow club members who love this hobby to the point that they actively promote amateur astronomy. They represent the hundreds of you who do the same. They are you and your club. So, please share in the praise I give to them because you've all earned it.

The first of my unknown astronomers serves on our Executive Committee. That's a bit like being a blood donor in Transylvania. The demands on his time and talents are many, and everyone wants whatever it is done immediately—if not sooner. He has served three terms in this hectic position. But, that's not all he does. This dedicated soul also finds time to show up at every club and public observing event we've had since he joined up. He happily totes his 10-inch Dob to school yards, local parks, and once a year to the wilds of Emily Park where upwards of 300 Girl Guides descend upon the club's scopes.

When Celestron came out with their 15×70 binocular bargains last year, he scooped up a pair. Two weeks later, he gave a presentation to the club highlighting the new binoculars as well as some tricks for making the most of them. A few other members brought along their binoculars. So we had a bino-fest with examples ranging from 7×50 hand-held units up to



Figure 1 — The Venus Transit brought out the usual scopes and a crowd of about 300.

25×100 models on mounts. It was a great open discussion in which everyone participated and everyone learned something.

Another of those unsung heroes who gets out and promotes astronomy is rumoured to not even own a telescope, though he claims it is only a small one. He has been a member of the club intermittently since 1972, when he was in high school. Today he serves on our Executive. But it's what he shares with us beyond his managerial skills that counts most.

At every meeting, he has printed copies of what's up in the night skies and distributes them to all of us. In 2012, he organized a very successful club tour to the David Dunlap Observatory. Plus, he is currently stirring up interest in an overnighter to the Montréal Planetarium. His organizational talents also include reserving and setting up the club's astronomy display at the local library. This year the theme is aurora, so he chased down as many club-member aurora photos and resources as possible for the display. No wonder his legs get progressively shorter each year.

While no one has ever seen his “invisible scope,” he's always on hand at Astronomy Day to set up the booths and displays. To the public, he is the face of amateur astronomy in Peterborough. He handles the booths and answers an unbelievable variety of questions on subjects ranging from telescopes and star clusters to black holes and exoplanets. Scope or no scope, he's our Mr. Show & Tell. To all of you like him, thanks for the extra effort.

Not all of our star-club members are on the club Executive. One of the most helpful guys around teaches school during the day and does as much astronomy as possible when the Sun goes down. He also owns an observatory and opens it up to club members during the summer. In addition to ogling the stars through the observatory's big refractor, there is enough acreage for club members to set up their own telescopes. So, we can have our club star party—and he supplies the coffee, doughnuts, and warm-up shack. Life is good.

From club observing sessions to public ones, he is always on hand. His knowledgeable explanation of astronomy topics assures that the line up at his scope is one of the longest. Perhaps our club is just lucky to have such members, but I'm sure we aren't the only ones with a few "doers" and a bunch of bench warmers.

I think all others across Canada who love astronomy enough to do more than just read about it. Whatever your club affiliation, if you find yourself in the "doer" category, take a well-earned bow. You and those like you are the engines of

amateur astronomy. Who knows, you may wind up powering the imagination of the next Neil deGrasse Tyson or Andrea Ghez.

As for the bench warmers, it's time to give something back to the hobby from which you've gained so much. ★

*John Crossen has been interested in astronomy since growing up with a telescope in a small town. He owns [www.buckhornobservatory.com](http://www.buckhornobservatory.com), a public outreach facility just north of Buckhorn, Ontario.*

## Second Light

### Rings Around an Asteroid



by Leslie J. Sage  
([l.sage@us.nature.com](mailto:l.sage@us.nature.com))

The outer four planets in the Solar System—Jupiter, Saturn, Uranus, and Neptune—all have rings around them. Mars might have rings of dust arising from the bombardment of its moons, Phobos and Deimos. But no one was expecting an asteroid to have rings. That, however, is just what Felipe Braga-Ribas of the National Observatory of Brazil and a global group of collaborators found—two rings around Chariklo, which is a body with a diameter of ~250 km in an orbit between Saturn and Uranus (see the April 3 issue of *Nature*—first published online on March 26).

To be technically correct, Chariklo is a Centaur object. Centaurs are "minor planets" with some of the characteristics of comets and some of asteroids, probably originating in the Kuiper belt (beyond Neptune) or the main asteroid belt. They are on unstable orbits between Jupiter and Neptune. There are estimated to be ~44,000 such bodies, with Chariklo being the largest. It was discovered in 1997, and its estimated dynamical lifetime is about 10 million years before gravitational interactions with Uranus send it onto a new orbit.

The rings were discovered during a "routine" occultation, if any occultation can actually be called routine. Occultations occur when Solar System bodies pass between us and a distant star. For very distant bodies, it is really the only way to investigate their basic properties, short of a spacecraft flyby (which would be prohibitively expensive). Because bodies in the outer Solar System are so distant, and typically quite small, often even their size is poorly known. Occultations are very difficult to observe because the orbits of the bodies can have considerable uncertainty, so predicting just where on Earth the path of the occultation (the "shadow") will land also has uncertainties. Typically, many telescopes at multiple locations are involved in the observations to account for these uncertainties and produce enough "chords" for the reconstruction of the object's

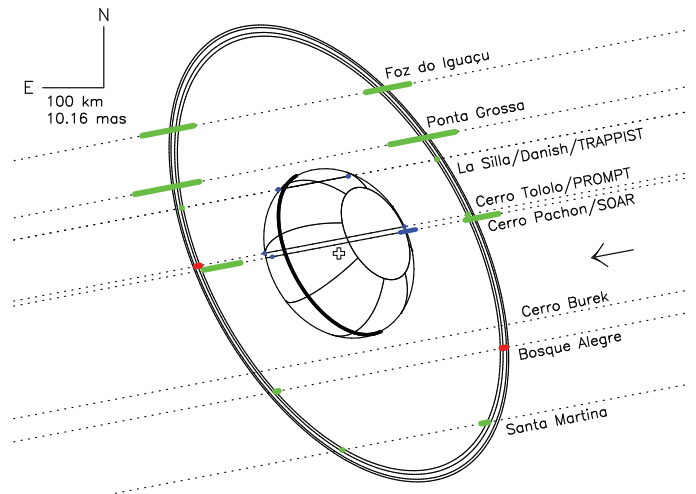

Figure 1 – The Chariklo ring system, showing the trajectories of the star as observed from the eight sites. Image courtesy of Felipe Braga-Ribas and Nature.

profile. Smaller telescopes are more portable, but are less sensitive. Finally, it is quite usual for at least one station to be clouded out at the time of the occultation.

Chariklo was predicted to occult a 12.4-magnitude star on 2013 June 3 with the path crossing South America. Braga-Ribas and his team were located on sites in Brazil, Argentina, Uruguay, and Chile. The star was occulted by Chariklo at three sites in Chile, but to their surprise, 13 smaller drops in the stellar brightness were recorded at seven sites. The Danish 1.54-m telescope at the European Southern Observatory's La Silla site was able to resolve the secondary occultations into two sub-events. The reconstructed paths observed by the telescopes are shown in Figure 1, along with the rings.

The inner ring lies about 390 km from the centre of Chariklo and has a width of ~7 km. It contains most of the mass in the ring system, equivalent to any icy body about 2 km across. There is a clear gap of 9 km, then the outer ring, which contains a mass equivalent to a body ~1 km across.

Early observations of Chariklo after its discovery showed evidence for a substantial amount of water ice, but between 1998 and 2008, it dimmed by about 40 percent and the water signature disappeared. Since 2008, it has gotten brighter again. It appears that when it was discovered, the rings were close to



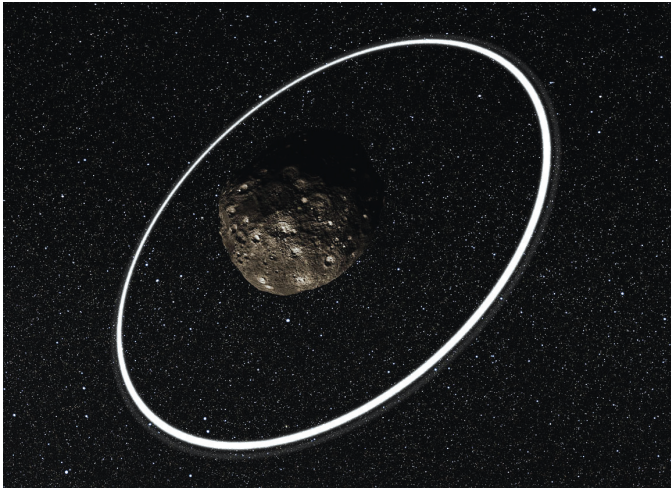

Figure 2 — An artist's impression of the Chariklo ring system. Image courtesy of the Creative Commons and Wikipedia.

face on, and although they have in total a small surface area compared to Chariklo, the icy ring particles are much more reflective than the solid body. The ring opening angle as seen from Earth changed with time (just as happens at Saturn), until the rings were edge-on in 2008. Since then they have opened again, and Chariklo has become brighter.

Collisions between the ring particles should cause the rings to spread in both width and thickness on a timescale of a

few thousand years; on longer timescales (millions of years) radiation pressure (light from the Sun) does the same thing. Braga-Ribas conclude that either the rings are very young, and we just happened to be lucky enough to see them, or they are confined by shepherd moons, as is true for some of Saturn's rings and proposed for Uranus' rings. In an accompanying News & Views, Joe Burns of Cornell University points out, however, that not all of Saturn's rings are confined by shepherds.

How did such rings form? Burns discusses some possibilities. He feels that the most likely explanation is a near-catastrophic collision like that which created the Moon. But the dust might gradually have accumulated from unseen companion bodies, in a process similar to that proposed for Mars.

Whatever the explanation, this surprising discovery emphasizes again that the Universe is more complicated than we can imagine. ★

*Leslie J. Sage is Senior Editor, Physical Sciences, for Nature Magazine and a Research Associate in the Astronomy Department at the University of Maryland. He grew up in Burlington, Ontario, where even the bright lights of Toronto did not dim his enthusiasm for astronomy. Currently he studies molecular gas and star formation in galaxies, particularly interacting ones, but is not above looking at a humble planetary object.*



## SkyShed POD MAX

Now completing development  
and launching shortly!

- Rugged construction (Built like a tank) 5.5" thick walls
- 6' 4" high wall with 32" wide door and a deadbolt lock
- Most affordable medium-sized dome ever
- Easy to assemble
- Multi configurations with POD MAX Bays and Dome only option
- Manual control to remote control
- Electronics by Kendrick Astro Instruments
- Designed for astro photography, education, and research
- Perfect for schools, clubs, and individuals with large scopes
- Ships to your door
- Pricing depends on model and level of automation. Please contact us for pricing.
- 12.5' dome with traditional slot design, 44" wide opening
- 20 degrees past zenith view



**Made in Canada for  
world wide export**

For more information please visit:

**[www.skyshedpodmax.com](http://www.skyshedpodmax.com)**

## Starless Masks



by Blair MacDonald, Halifax Centre  
([b.macdonald@ns.sympatico.ca](mailto:b.macdonald@ns.sympatico.ca))

This column continues a group of Imager's Corner articles that will focus on techniques that are useful in processing astrophotos.

Over the next several editions of the *Journal*, I'll continue with a guide to several techniques that I find most useful.

In my last column, we looked at masked stretching as a way to control star bloat. In this edition, we will look at a way of generating the required starless masks. Several astro-imaging packages have functions that make this relatively straight forward, and we will take a look at one such function in *ImagesPlus*. First though, let's look at a way of generating the masks using any layer-capable image processor.

The general idea is to use a blurring filter to remove the stars while protecting the rest of the image with a star mask. First, let's take a look at a way to make a high-quality star mask. The following Veil Nebula image shows some promise, but we need a good, starless mask to control the star bloat.



Figure 1 — Part of the Veil Nebula embedded within a rich star field

Start by duplicating the image on a second layer and slightly blur it with a small radius Gaussian filter, say three to four pixels. Set the blend mode of this layer to subtract or difference. The slight blur will reduce the brightness of the stars, because they contain mostly high-frequency information, while the nebula and background remain unaffected, since they contain lower-frequency data. With a "subtract" blend mode, the difference in the star brightness leaves a faint star while removing the nebula almost completely. This works well for the small stars, but will miss the larger ones, as they contain more low-frequency information. To get the larger stars, duplicate the image on a third layer and assign a threshold that leaves

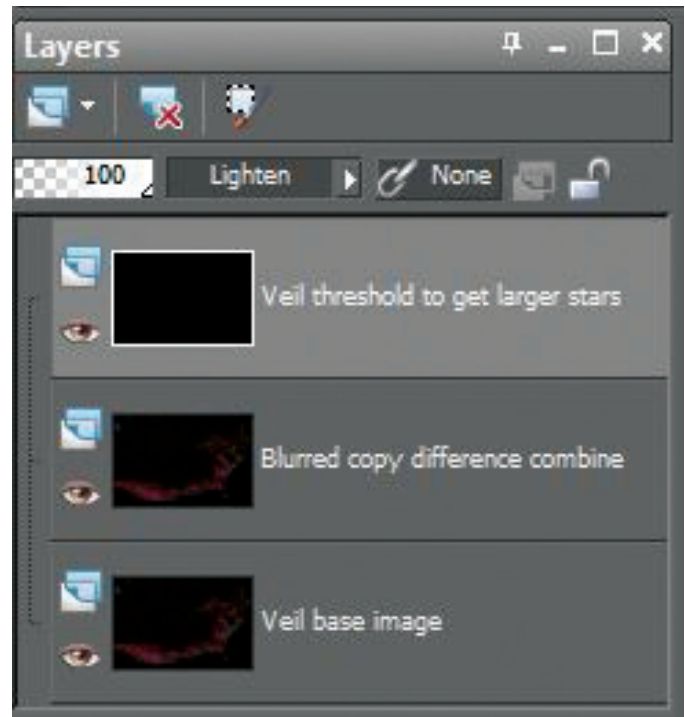

Figure 2 — Star mask layer stack

only the brightest and thus largest stars. Set the combine mode of this layer to "lighten" and combine all three layers.



Figure 3 — Star mask

Finally, threshold the result to make the final mask. Experiment with the threshold level to leave the stars and remove as much of any remaining nebula as possible. Use the paint tools to clean up any nebula remaining and use a "dilation" to expand the stars by a pixel or two to produce the star mask. Now comes the first step in producing a starless mask. Open the original image, and duplicate it on another layer. Set the combine mode to "difference" on the top layer. Then apply the star mask to the top layer and presto, you get an image that has the stars replaced with black circles the size of the white areas in the star mask (Figure 3).



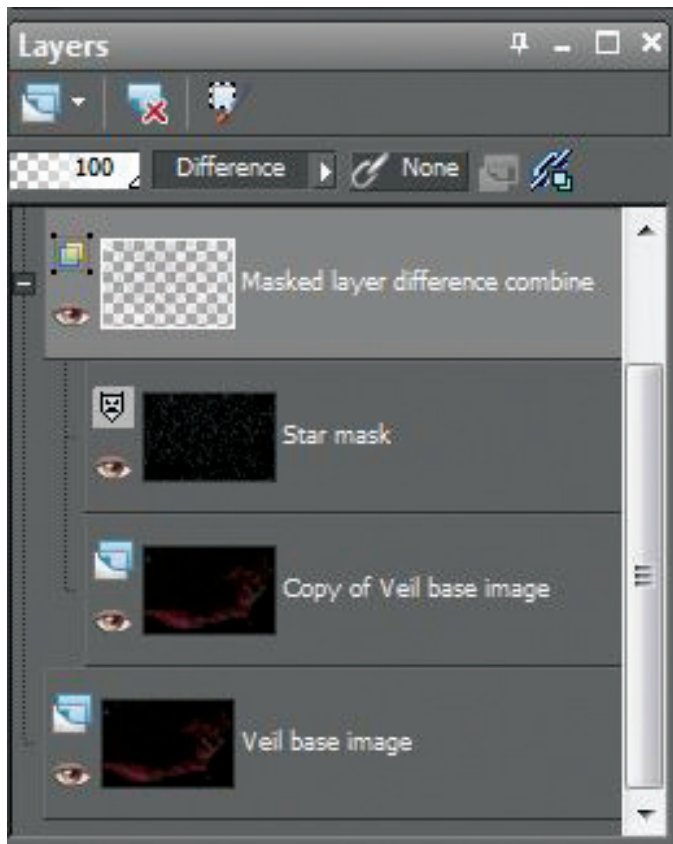

Figure 4 – Image stack to remove stars

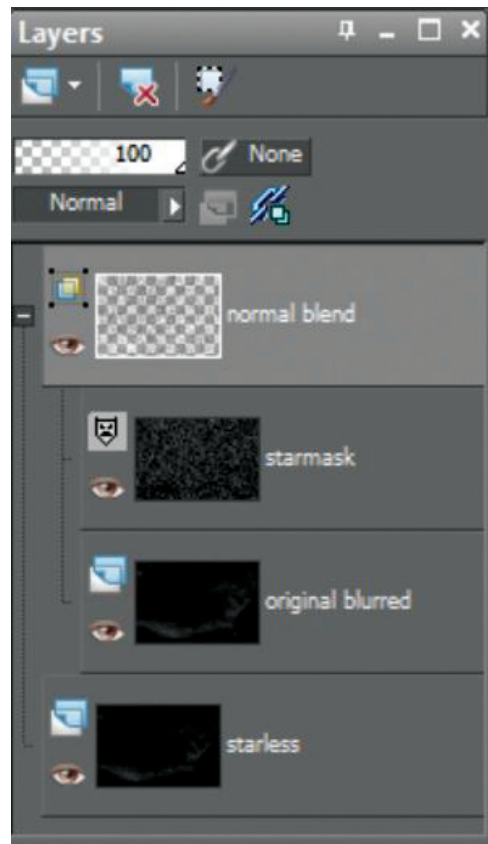

Figure 6 – Final mask stack

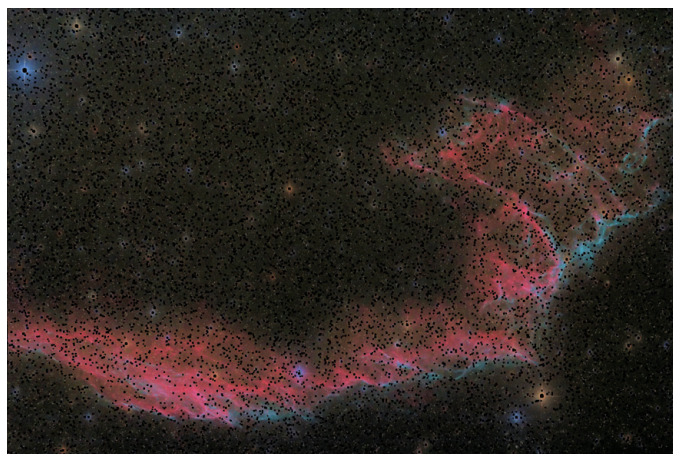

Figure 5 – Image without stars

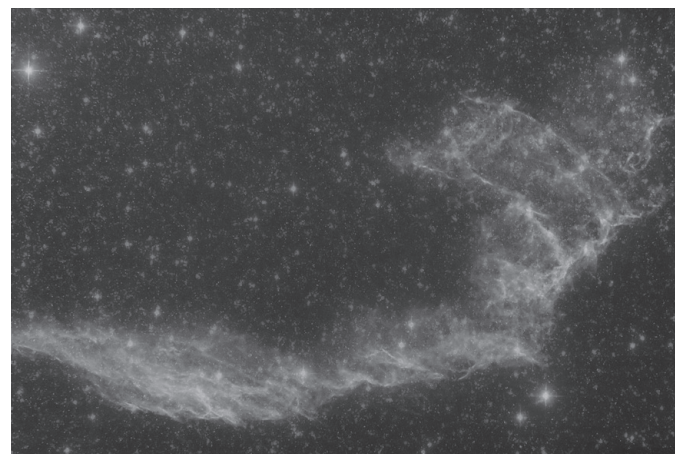

Figure 7 – Starless mask

The next step is to convert the image to monochrome. Once this is done, the original image is converted to monochrome and loaded as another layer on top of the starless image. The star mask is added to the top layer and the layer is blurred to blend in the missing data in the lower layer (Figure 4). Increase the blur radius until you get the best blend with the fewest stars. Flattening the stack produces the final mask, ready for touch-up with a clone tool.

Some of the larger halos can be removed using the clone tool and a little blurring. This will leave you with a mask that has most of the detail of the initial image and can be used for masked stretching to greatly increase the fine detail in the image.

As you can see, there is a fair bit of work involved in creating these masks, but the final result will be worth the effort (Figure 7).

Some astro-specific processing packages have various tools that make mask generation much easier. *ImagesPlus*, in particular, has added a variety of masking tools, with one of the best called “a feature mask tool.” This handy function can be used to quickly and interactively generate starless masks. The tool has much more capability than just mask generation: with a few mouse clicks you can actually produce two full-colour images, one with just the stars and another with the nebula or galaxy without the stars. This allows simple split-star processing that

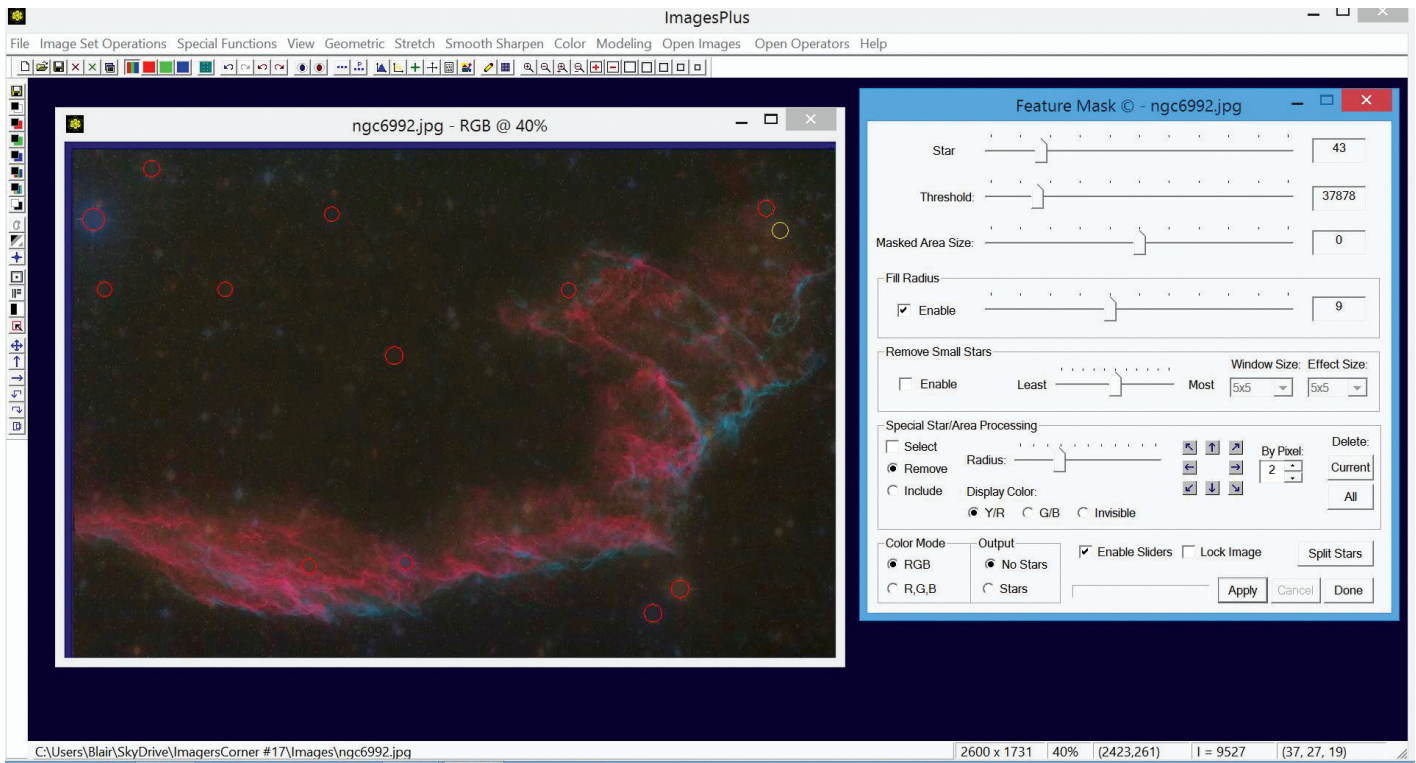

Figure 8 – Images Plus feature mask tool

can produce detailed images with tight, small stars, but that is a topic for a future edition. I'll cover this tool in detail in an upcoming edition, but here are the simple steps to making a starless mask using the tools built into *ImagesPlus*.

Just like the previous technique we will start with the original Veil shot and open the feature mask dialogue to begin the process. In that dialogue, you can adjust the star slider to set the maximum size of stars to remove, the threshold slider to tell the tool how much something has to resemble a star to be removed, and the other sliders to allow you to fine-tune the results.

Once the stars have been removed, then the image can be converted quickly to a luminance mask. This tool turns a

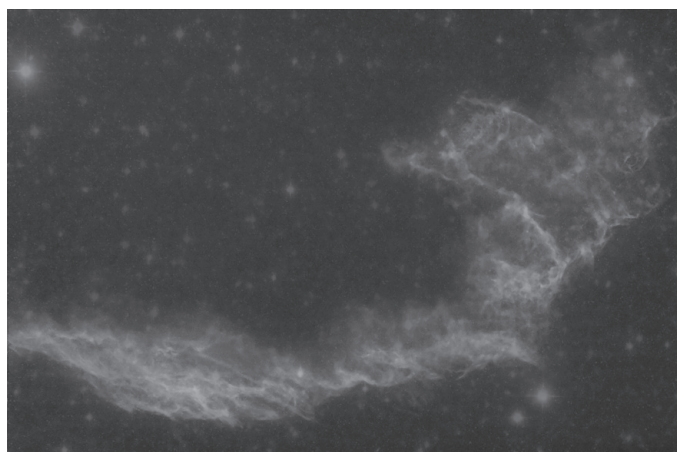

Figure 9 – Images Plus starless mask V

tedious sequence of steps into an essentially automated process that generates high-quality masks with a few mouse clicks.

Remember, this column will be based on your questions so keep them coming. You can send them to the list at [hfxrasc@lists.rasc.ca](mailto:hfxrasc@lists.rasc.ca) or you can send them directly to me at [b.macdonald@ns.sympatico.ca](mailto:b.macdonald@ns.sympatico.ca). Please put "IC" as the first two letters in the topic so my email filters will sort the questions. ★

*Blair MacDonald is an electrical technologist running a research group at an Atlantic Canadian company specializing in digital signal processing and electrical design. He's been an RASC member for 20 years, and has been interested in astrophotography and image processing for about 15 years.*

### Is your address correct? Are you moving?

*If you are planning to move, or your address is incorrect on the label of your Journal, please contact the office immediately.*

*By changing your address in advance, you will continue to receive all issues of SkyNews and the Observer's Handbook.*

**(416) 924-7973**

**[www.rasc.ca/contact](http://www.rasc.ca/contact)**



# Planets Crossword

by Naomi Pasachoff

## ACROSS

1. Mythical supporter of celestial sphere
6. Brawl
10. Designer of World Trade Center memorial
14. Transition between land and sea
15. Descartes or Magritte
16. Shampoo and conditioner brand
17. Smallest distance for a moon to orbit a planet without being torn apart
19. “\_\_\_\_\_ See Clearly Now”
20. Summer, in Sceaux
21. Gifts for feast-ending Ramadan
22. Round wax-covered cheeses
23. Long-lasting atmospheric storm on Jupiter
26. Hilton’s \_\_\_\_\_ Suites
29. Stieglitz’s “\_\_\_\_\_ Day on the Boulevard”
30. A comet’s dust or ion \_\_\_\_\_
31. Tandoor or imu
32. Samuel Clemens, \_\_\_\_\_ Mark Twain
35. He discovered Uranus
40. NPR’s \_\_\_\_\_ *Things Considered*
41. *Carpe* or *per* follower
42. Beatles album
44. Economizes
47. It orbits near the edge of a planetary ring
51. Part of AV
52. Relaxation
53. Plant associated with Gregor Mendel
56. Disney chairman
57. Saturn’s rings extend far out into its \_\_\_\_\_ plane

1	2	3	4	5		6	7	8	9		10	11	12	13	
14						15					16				
17					18						19				
20				21						22					
			23					24	25						
26	27	28						29							
30							31					32	33	34	
35					36	37	38					39			
40				41							42				
			43					44	45	46					
47	48	49						50							
51								52					53	54	55
56						57	58					59			
60						61					62				
63						64					65				

60. Actress Moore
61. Sierra Club founder
62. Lather, \_\_\_\_\_, repeat
63. “I smell \_\_\_\_\_”
64. Apple products
65. Marching band uniform accessories \_\_\_\_\_
18. Prevaricates
22. Mid-20th-century Prime Minister Sir Anthony and family
23. Chutzpah
24. Party with electronic music and light shows
25. America’s Cup, *e.g.*
26. Really, in Regensburg
27. You’ve Got \_\_\_\_\_
28. President Clinton or Senator Bradley
31. Unit of electrical resistance
32. Throat-clearing sound
33. Marine algae type
34. Mont Blanc is its highest peak
36. Where Coeur d’Alene is
37. “Darling, Je Vous \_\_\_\_\_ Beaucoup”
38. Israeli Prime Minister Golda
39. Take it on the \_\_\_\_\_
43. Opportunity’s twin
44. Ad hominem attacks
45. Price
46. Turbulent meteorological vortices
47. “I’ve \_\_\_\_\_ lot of things”
48. Much bigger
49. Swelling
50. Shapeshifting World of Warfare class
53. Dancer-choreographer Bausch
54. Direction most planets rotate
55. Relatives of lagers and stouts
57. Interactive Seattle museum
58. Status follower
59. Tear to shreds

## DOWN

1. Hectare relative
2. \_\_\_\_\_ one’s own horn
3. Wedding dress fabric
4. Combustion product
5. Guides
6. Part of TGIF
7. Send a payment
8. Singer-songwriter DiFranco
9. “Are we there \_\_\_\_\_?”
10. Encompassed by
11. Summarize
12. Hertz competitor
13. Actress Kristen

# Fun With Arduinos—Part 2

## An Arduino-Based Focus Controller



by Rick Saunders, London Centre  
(ozzy@bell.net)

This project describes how to build and control a stepper motor for a telescope focuser using a minimum of components.

I used a standard Arduino Diecimila microcontroller board (<http://arduino.cc/en/Main/ArduinoBoardDiecimila>), but any Arduino that uses the same shield form factor can be used. The parts list is:

- 1 Arduino development board
- 1 Chinese Arduino proto-board
- 1 ULN2003 Darlington array chip
- 1 16-pin IC socket
- 2 momentary tactile switches with caps
- 2 5-mm LEDs
- 2 2K2 Resistors
- 1 5-pin header
- 1 Hammond 1591xx project case
- 1 Keystone RJ11 (6p6c) plug
- 1 on-off-on toggle switch
- some bits of wire

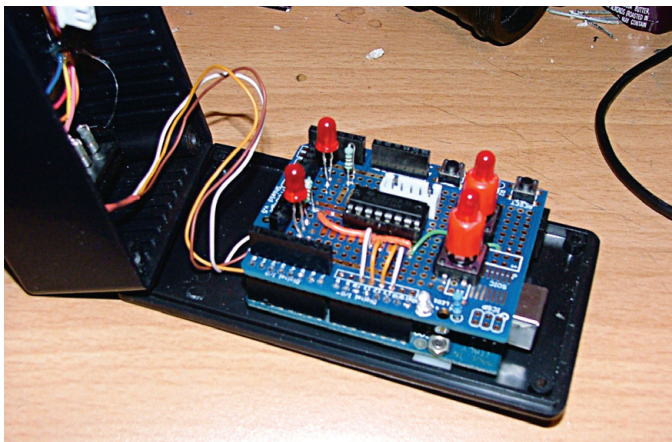

Figure 1 — A view of the layout of the OzFocus

The prototype board is modified slightly. I removed one of the female pin-headers in order to make connecting the input wires to the ULN2003 a little less unwieldy. The switches (other than the toggle) and LEDs are mounted to the prototype board. The toggle switch is mounted in the Hammond case along with the RJ11 plug. The RJ11 connects to the 5-pin header on the prototype board. I'll probably add a 3-pin header to plug in the toggle switch. A design schematic is displayed in Figure 2.

Note that the switches' caps didn't extend far enough to make it through the top of the enclosure, so I hollowed out the tops and glued in some 5-mm LEDs to extend their height. Not pretty, but they work just fine.

The Arduino is jumpered to take its power from the barrel jack, which plugs into the 12V source needed by the motor I'm using. If you use an Arduino Uno, this is done automatically.

The two buttons make the focuser move in and out. The toggle switch sets the speed to either double, normal, or one-half. One LED shows that power is connected, the other flashes to show that the motor is activated. The 5V and GND strips on the prototype board are used as needed.  $V_{IN}$  is brought over to the ULN2003 on the bottom of the board. The wires from the switches to Arduino pins 6 and 7 also run on the bottom of the board, as are the toggle-switch wires, which are soldered to the bottom.

### Firmware

The unit responds to the following commands over the serial line. Return values are shown on the right.

#### Meade LX200 commands

#: F+#	Focus out	
#: F-#	Focus in	
#: F0#	Focus stop	
#: F[ 1 - 4 ]#	Focus speed 1/4, 1/2, 3/4, full	
#: FF#	Focus fast speed	
#: FS#	Focus slow speed	
#: GV#	Show firmware version	OZ1.0

Several other #:Gx# commands are supported in order to make the focuser compatible with the Meade LX200GPS/R ASCOM driver.

#### OzFocus LX200 extensions

#: Fp[int]#	Move x number of steps (+/-)	
#: FG[int]#	Goto position x	
#: FX[int]#	Set position x as maximum	
#: Fx#	Show maximum	Integer
#: FR[int]#	Set the baserate (ms)	
#: FP#	Show current position	Integer
#: FD#	Swap in/out direction	
#: FZ#	Put focuser to sleep	
#: F0#	Set current position to 0	
#: FI#	Set current position to max	
#: F?#	Is the motor turning?	[0 1]

As the focuser moves, either by manual control via the buttons or via serial command, the focuser's current position is stored. When movement stops, the position is stored to EEPROM. Also stored in EEPROM are the stepper motor's base rate (milliseconds between steps) and the maximum number of steps between 0 and full travel.



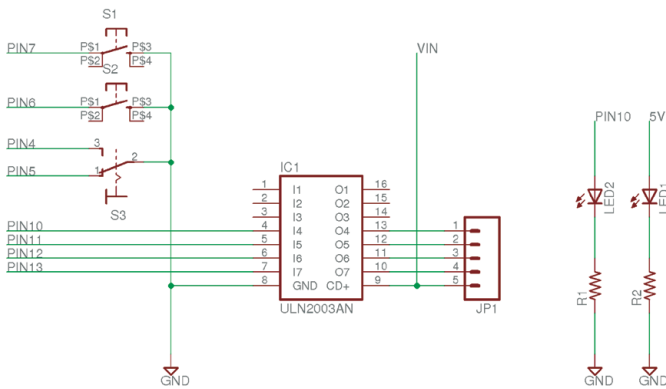

Figure 2 – A schematic of the prototype.

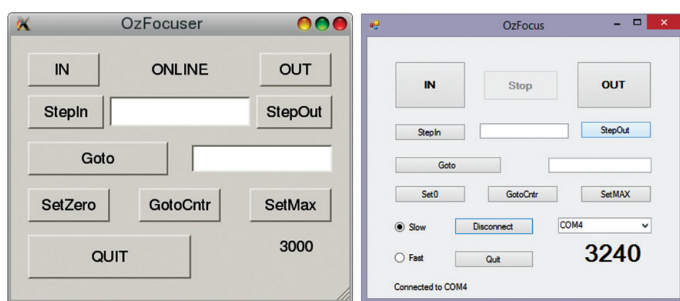

Figure 3 – Focuser display for Linux (left) and Windows (right).

## Software

The software for the project comes in two flavours, each with a different screen display. One is for *Linux* (Figure 3, left) and the other is for *Windows* (Figure 3, right). The *Linux* software was written in *GTK-PERL* and is simple to use or modify. The *Windows* software is a *VisualBASIC* application and comes as an executable. Neither exposes all of the commands that the controller uses, but has enough features to make the controller work. The commands that are not available to the software can be set with a serial application (such as the Arduino IDE).



Figure 4 – The finished focuser.

On startup, the *Linux* software will attempt to open a stupidly named, non-existent serial port and of course, won't be able to. It will then display a little window that will allow you to tell the software what port your system assigns to the controller and then will connect. If, in later sessions, the serial port name changes, the same will occur. The serial port in use is stored in a file called *focuser.conf* in your home directory.

The *Windows* software will find all of the valid serial ports on your computer and show them in a drop-down box. Select the correct one, and click **Connect**. Nothing is stored on the computer.

The focuser's current position is displayed in the bottom right and is usually updated automatically. The *Windows* version won't update during manual focusing, just to make it "peppier," but as you will probably be looking at an image of the star while focusing, the position isn't important. In any case, the position will be displayed when you release the button.

To focus in or out, just click the **IN** or **OUT** buttons. The unit is activated as long as the mouse button is held down. The position indicator updates periodically while the button is pressed. The vagaries of timers is such that, while the motor has stopped, it may take a bit for the new position to show up (*Linux*). To step in or out a specified number of steps, just enter the number of steps in the entry box between the **StepIn** and **StepOut** buttons, then press the appropriate button. The position will update as the focuser moves.

To move to a specified position, enter the position in the box next to the **Goto** button then press the button. The focuser will move to the desired position. The position display will update as the focuser moves. To move to the focuser's centre position (half way between 0 and full travel), click **GotoCntr**.

Calibrating the controller for the physical focuser is simple. Power on the unit, then slide the focuser drawtube all the way out and tighten it. Next, click the **SetZero** button; this will set the current position at 0. Now use the "focus out" button to manually run the focuser all the way until it reaches the end, then click on the **SetMax** button. Now the unit knows the limits of its travel, and you're ready to work.

If you wish to use the focuser with an ASCOM-enabled application, select the Meade LX200 GPS/R driver.

The project software and Arduino sketch can be found at: [www.togastro.com/ozzy/OzFocus.zip](http://www.togastro.com/ozzy/OzFocus.zip). ★

*Rick Saunders became interested in astronomy after his father brought home a 50-mm refractor and showed him Saturn's rings. Previously a member of both Toronto and Edmonton Centres, he now belongs to the London Centre and is mostly interested in DSLR astrophotography.*

# John Percy's Universe

## Outreach!

by John R. Percy  
(john.percy@utoronto.ca)



Figure 1 — University of Toronto astronomers, in partnership with the Alumni Association, the Institute for the History and Philosophy of Science and Technology, and the RASC Toronto Centre, organized a very successful viewing of the 2012 Transit of Venus, attracting over 5000 people to Varsity Stadium. Dunlap Institute Photo

The RASC excels in public outreach, at the national, local, and individual level. Our Society won the national *Michael Smith Award* in 2003 for excellence in bringing science to the public. I recently (Percy 2012) reflected on my own half-century of experience in astronomy outreach and, in an earlier article in this *Journal* (Percy 2002), I explained why we should do outreach and how to succeed. This article is a short update, summary, and how-to guide. It supplements other excellent guides, such as the recent one by Paul Heath (2014).

Why do public outreach? The reasons may differ, depending on whether we are amateur or professional astronomers. We do it to increase public awareness, understanding, and appreciation of our science, *i.e.* to increase public science literacy. We professionals should do it also to be accountable to the public, who fund our salaries and our research. We also want to present a positive image of science and scientists, *i.e.* “public relations.” In universities, we want to attract young people to science, and to attract the best students to our university, *i.e.* recruitment. Outreach sometimes leads to major donations: it was Clarence Augustus Chant’s outreach that ultimately led to the gift of the David Dunlap Observatory to the University of Toronto.

For our students, a growing trend is “community service learning,” in which they learn by doing practical projects in the community—especially for worthy non-profit organizations. Students are engaged in outreach in other ways: in my department, public tours are run by graduate students<sup>1</sup>. At York

University, undergraduate students are very active in running their public outreach programs, including their campus observatory<sup>2</sup>. RASC Centres may do outreach to attract more members. But in astronomy, we *all* do outreach, because we love astronomy and want to share it with others. We want to inform, entertain, and inspire. Astronomy is exciting. Outreach is deeply rewarding—and fun!

There are many forms of outreach. One is communication through print or electronic media—books, magazines, newsletters, Web sites. Another is lectures: almost every RASC Centre holds lectures for the public as well as for its members. There are eyes-on experiences such as star parties in a variety of locations from street corners to city parks to dark-sky preserves. Some of these activities can be in schools, either in a formal class setting, or after school. See Heath (2014) for an even more comprehensive list.

All of these forms of outreach can be approached with a basic set of guiding principles, which have been expressed in many forms. The one below is based on work by noted science educator Derek Hodson.

### Objectives

What is your purpose and goal in doing this outreach activity? Is it to educate, inform, entertain, inspire, recruit, fundraise, or engage? I would hope that, whatever your objectives, one would be to leave the audience enthusiastic about astronomy and astronomers. It often helps to partner with other organizations that share our goals: libraries, science centres, colleges, and universities. Figure 1 shows some of the 5000+ people who observed the 2012 transit of Venus in Varsity Stadium at the University of Toronto, at an event organized by several partners, including the RASC Toronto Centre.

And, what are the nature, needs, motivation, and expectations of your audience? (If you don’t know, ask!) If the activity is for families or children, it must be fast-paced, hands-on or eyes-on (if possible), simple, and especially engaging. Adults can tolerate a one-hour lecture—if it is interesting. Older adults will appreciate a microphone, and larger print on handouts and slides.

There is a special need to attract young people, women, minorities, and the disadvantaged to astronomy. In North America, amateur astronomy is becoming the preserve of greying, white males like me. Astronomy is part of *every* culture in Canada, including our First Nations. And, people of both genders, and all ages and cultures are interested in space exploration, black holes, cosmology, and the possibility of extraterrestrial life, as well as astronomy’s connections with their own history and culture.

It helps to be aware of the many misconceptions that people have about astronomical topics, from the cause of the seasons,



to pseudoscientific beliefs about astrology, space aliens, and creationism. Neil Comins (2001) has published a book about these, and maintains a list of over 1700 of them on his Web site<sup>3</sup>.

## Curriculum

Having decided on your objectives, what should you include in your activity? One or two topics in depth, or a broad (and perhaps exhausting) array? A good look at the Moon and Saturn or a quick look at the whole Messier Catalogue? It's also tempting (especially in a classroom) to over-emphasize *content*. In fact, we also want to convey *skills* such as critical thinking and how to *observe* (rather than just glance) through a telescope. It helps if we can talk *with* audience members, not just *at* them. Then we can cater to their personal interests and experiences, and also find out whether they understand what we have told them, or shown them.

We want them to know why the topic is relevant, useful, or interesting to them. I always like to inject some "Canadian content," especially as taxpayers are paying for astronomical research. Too many Canadians think that all astronomical discoveries are made by NASA with the *Hubble Space Telescope*, and are unaware that Canada is one of the world leaders in astronomy.

Most of all: we want to make sure that our audience comes away with a positive feeling about us, and about astronomy. The biggest buzzword in university education today is engagement. We want our audience to be engaged, and inspired.

## Delivery

Whatever the outreach activity, it should be delivered in the most effective way possible, *i.e.* with "best practices." (As an aside: few, if any, university teachers have any training in effective teaching!) Knowing astronomy does not guarantee expertise in communicating it, though it does help. You should be aware of the audience's prior knowledge of astronomy and—as mentioned above—the fact that much of it may be wrong. Children, and many adults, may not be capable of immediately grasping abstract concepts and graphs and equations, or appreciating the scale of the Universe, or dealing with 3-D and "frame of reference" concepts such as the cause of Moon phases.

In formal education, *inquiry-based* is the gold standard. Are the students' minds engaged? Hands-on is always good, especially for children, and the RASC and many of its Centres have developed engaging handouts (such as the IYA planispheres), models, and other hands-on materials. To paraphrase astronomy educator Tim Slater: What the students/audience do is more important than what the instructor does. Get the audience to do, estimate, predict, think, and discuss.

Lectures are not very effective for teaching content but, if done well, can still be useful, if the lecturer is clear, concise, enthusiastic, and interested in the audience. The rules are simple: plan, organize, and rehearse; divide the material into short segments; be clear, concise, and *enthusiastic*; use simple language and analogies, and avoid jargon; be audible and make visuals visible; leave ample time for questions and discussion.

## Evaluation and Feedback

Every activity in life should be subject to *assessment*, which includes both evaluation and feedback. The assessment can be through formal research, through a simpler version called "action research,"<sup>4</sup> through a short but well-designed questionnaire, or simply through reflection.

There is *formative assessment*, which is done during the activity, and therefore provides immediate feedback, and there is the usual *summative assessment*, which is done at the end. In either case, it is important to use the assessment for *feedback*, to ensure that the activity is done even better next time.

In conclusion: Keep up the good work in outreach, both nationally and locally! Since outreach is a large and important part of the Society's work, give it a high profile in our publications and meetings. Many Centres offer lectures, workshops, and courses on general astronomy, on observing, on astro-imaging, *etc.* Offer such programs on education and outreach as well. That will help to get more Centre members involved in and good at outreach. Share your successes and ideas through RASC publications and on-line forums. Recognize and reward RASC outreachers, both nationally and locally; the recently created Qilak Award is an excellent step forward. ★

## References

- Comins, Neil F. (2001). *Heavenly Errors*. New York: Columbia University Press.
- Heath, P. (2014). Volunteering: A Guide (Part 1). *JRASC*, 108, p. 8-13, February.
- Percy, J.R. (2002). Outreach: Why You Should Do It, and How to Succeed. *JRASC*, 96, 196-202, October.
- Percy, J.R. (2012). A Half-Century of Astronomy Outreach: Reflections, and Lessons Learned. *JRASC*, 106, 240-248, December.
- John Percy is Professor Emeritus, Astronomy & Astrophysics, and Science Education, University of Toronto, and Honorary President of the RASC.*

- 1 <http://uoft.me/astrotours>
- 2 <http://astronomy.blog.yorku.ca>
- 3 [www.physics.umaine.edu/ncomins](http://www.physics.umaine.edu/ncomins)
- 4 [http://en.wikipedia.org/wiki/Action\\_research](http://en.wikipedia.org/wiki/Action_research)

# Through My Eyepiece

## Spring has Sprung



by Geoff Gaherty, Toronto Centre  
(geoff@foxmead.ca)

I'm writing this in the last days of March after one of the longest, coldest, snowiest, and blowiest winters in my lifetime, and that of most Canadians. I find myself desperately needing an astronomy "fix."

I've noticed that most of the discussion on RASCals in recent weeks have been complaints about the weather. The recent big astronomical event, the occultation of Regulus by the asteroid Erigone, was clouded out for *everyone* along a path that crossed some of the most populated areas in eastern North America. Apparently only a handful of people in Bermuda could even see Regulus, and they didn't see it occulted. But of the literally millions of people along the occultation path on the mainland, from Long Island to Hudson Bay, not a single one saw a thing.

By the time you read this, it will be early summer, and the winter a distant memory. But right now, for me, there is still an amazing amount of snow on the ground, though finally I can see most of the deck of my observatory, and I may be able to set up my solar telescope this morning.

One of the disadvantages of living in the country is that I begin to take the night skies for granted, and they become a bit "same old, same old." It's only after such a long hard winter

that I begin to appreciate the night skies (and the day skies) more. I find myself champing at the bit to fire up my telescope and check out the spring galaxies and planets. The winter constellations, which it's been too darned cold to look at for months, will still be there in the west, too.

My old friend Jupiter will be around for a while still, Mars comes to opposition in a week, and Saturn is rising in the late evening. My first love has always been the planets, and I look forward to seeing them again in my telescope.

One of the disadvantages of getting old is the increasing aggravation of arthritis. Observing in cold weather is more than just uncomfortable: it's downright painful. I confess I've become a fair-weather astronomer, but there's no shame in that. After all, astronomy for most of us is a hobby, and hobbies are *supposed* to be fun, and there's no fun in aching fingers. Soon I'll be handling my eyepieces without fear of dropping them because of frozen fingers.

So, today I'll enjoy the Sun's returning warmth and its current crop of prominences, and in a few nights' time it will be warm enough to fire up the Celestron and have a look at planets and galaxies. This is my favourite time of the year, astronomically and otherwise, and I'm looking forward to it.

Clear, warm, and snow-free skies!

*Geoff Gaherty received the Toronto Centre's Ostrander-Ramsay Award for excellence in writing, specifically for his JRASC column, Through My Eyepiece. Despite cold in the winter and mosquitoes in the summer, he still manages to pursue a variety of observations. He recently co-authored with Pedro Braganca his first iBook: 2012 Venus Transit. \**

## Reviews / Critiques

**Discovery and Classification in Astronomy: Controversy and Consensus**, by Steven J. Dick, pages 458+xvi, 18 cm × 25 cm, Cambridge University Press, 2013. Price \$45 USD, hardcover (ISBN: 978-1-107-03361-0).

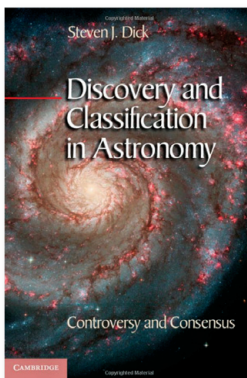

*Discovery and Classification in Astronomy* by Stephen Dick is a difficult book to categorize. Ostensibly its purpose is to discuss the classification of astronomical objects and how their discoveries originated, touching on the controversies surrounding them and how they are ultimately resolved, at least according to the book's subtitle. The book itself also introduces its own

new classification scheme for astronomical objects, although the result seems both incomplete and overly complex on first scrutiny.

My initial impressions of *Discovery* were generally favourable. Dick's writing in the early chapters is an order of magnitude better than a typical paper published currently in any refereed journal. I was hard-pressed to find errors in the written text; the best I could manage being a missing word in Chapter 1. But, the writing style itself is rather pedantic and pretentious, spending far too much discussion on unimportant aspects of astronomical history while skipping important points. In most cases, the significant discoveries related to each topic are overlooked or left unstated, most being serendipitous after all, while the technological advances that led to the discoveries are often unnoticed. Typographical errors and poor word usage begin to creep in more and more as one delves deeper into the manuscript, gradually leaving a poor overall impression of the book's quality.



Much of the Introduction and all of Chapter 1 are devoted to The Pluto Affair, with a lengthy discussion of the IAU debates that resulted in Pluto's reclassification as a Dwarf Planet. The fundamental point of the affair appears to be missed. Pluto was discovered as a result of searches begun by Percival Lowell following his prediction of the putative missing massive planet's likely location. The ultimate discovery by Clyde Tombaugh in 1930 was more a case of coincidence than of the accuracy of Lowell's prediction, given that Lowell's original calculations for the object perturbing the orbits of Uranus and Neptune used erroneous estimates for the masses of the giant planets. Likewise, James Christy's 1978 discovery of Pluto's satellite Charon was also serendipitous in nature, with the important point being that it took a keen eye to notice that the image of Pluto on photographic emulsions was occasionally elongated rather than a result of poor guiding of the original exposures.

And Pluto's ultimate "demotion" by the IAU was tied more than anything else to the observational verification in the '90s of the Kuiper-Edgeworth (KE) belt, the existence of which had been postulated in order to explain the sizeable population of low-inclination orbits for comets of very long period. It did not help that the observational searches for KE belt objects also turned up a number of planetary objects sharing Pluto's unusual 3/2 orbital-period resonance with the planet Neptune. The main question resulting from those discoveries remains unanswered. Models of the early Solar System seem to rule out the formation of planetary objects in the outer Solar System *in situ* within its 4.5 billion year lifetime, so what transpired in order for Pluto and the KE objects to end up in their present locations far from the Sun? Such questions also arise in the inverse sense for many of the Jovian-mass extrasolar planets discovered to date, given their apparently unlikely formation in close proximity to their parent stars. For that matter, has a consensus actually been reached in the matter of Pluto's reclassification?

The story continues with moons, rings, and asteroids in Chapter 2, nebulae in Chapter 3, stellar classes and extrasolar planets in Chapter 4, and galaxies, quasars, and active galactic nuclei (AGNs) in Chapter 5. Later chapters deal with the nature of discovery and classification of objects, and how they relate to discoveries in other sciences. But the story in the early chapters is misguided and incomplete. Once again, essential points are often overlooked. Huygens's identification of Galileo's lobes for Saturn as a fixed ring system was ultimately tied to the disappearance of the rings at intervals corresponding to half of Saturn's orbital period (Fig. 2.4 of text), which is not emphasized in the text. I have made a number of discoveries myself in my astronomical career, certainly some that were controversial. Those that ultimately proved to be important were ones that advanced the field, not necessarily those for which a consensus was reached. Today's consensus opinion may end up as yesterday's imperfect science,

so it is unclear to this reviewer why the term features in the title to *Discovery*.

As a whole, *Discovery and Classification in Astronomy* is a slanted and incomplete history of some of the more important discoveries in astronomy that generally misses the important points and tends to garble the order in which different observations led to the ultimate discoveries. The discovery of extrasolar planets, for example, omits entirely the important work of Canadian astronomers Bruce Campbell and Gordon Walker in the 1980s in reducing uncertainties in radial velocity measures for stars from kilometres per second to metres per second, not to mention their possible discovery of Jovian-mass companions to a few stars. Ultimately, it was efforts begun by astronomers like Roger Griffin at Cambridge to improve the method of deriving stellar radial velocities that years later culminated in novel spectrograph designs for telescopes such as the French Coravel spectrograph and the first confirmation of planetary-mass objects orbiting nearby stars. The field later blossomed with the use of CCDs and other detectors to record transits and occultations of planets orbiting stars. *Discovery* leaves the impression that such discoveries were a gradual process beginning with detections postulated from proper-motion perturbations 60-70 years ago, whereas it was the dramatic increase in precision for astronomical radial velocity and photometric measurements made in recent years by technological improvements that resulted in advances to the field.

I was also puzzled by the discussion surrounding the discovery of black holes. As in much of the text, some astronomers are omitted, while others, mostly American, are given prominence for their discoveries. Tom Bolton is left unnamed, for example, in the discussion of Cyg X-1, although an enlightened reader might detect his presence in the term "one astronomer" used by Dick. Tom's work on spectroscopy of Cyg X-1 at the David Dunlap Observatory (DDO) was apparently not worth mentioning. Nor was the work of John Hutchings at the Dominion Astrophysical Observatory (DAO) in confirming the existence of supermassive black holes at the centres of some galaxies. The sole Canadian discovery cited is the coincidence of the variable star BL Lacertae with a strong radio source noted by John Schmitt while at the DDO. Yet it was spectroscopy of the "fuzz" around BL Lac itself, decades later, that ultimately led to the realization that it was a relatively nearby quasar-like galaxy, ultimately to lead to the term blazar. That is left unmentioned.

After reaching a point of frustration one third of the way through *Discovery*, I reached for my copy of George Abell's *Drama of the Universe* (Holt, Rinehart, and Winston 1978), which provides much more interesting and comprehensive summaries for most of the discoveries mentioned by Dick. The contrast was striking. The writing in *Discovery* displays much less familiarity with astronomical research and observa-

tion than that of Abell. Lack of astronomical expertise may also explain the author's use of the term "theory" throughout the text when practising astronomers wary of public perception regarding that word always use the term "model," which is invariably closer to reality.

Some typos of note: (i) eleven Jupiter masses on p. 112 is actually 0.01 solar mass rather than ".001 of the Sun," and (ii) while Hubble indeed "used the period-luminosity relation of Population I Cepheids for his distance determinations to the Andromeda Galaxy" (p. 120), he was NOT "actually observing Population II stars." That mistake discourages most astronomy instructors when it appears in student answers on final examinations. Hubble's distance to M31 was actually underestimated because the calibration of the period-luminosity (PL) relation for classical Cepheids was erroneous in his era (see informative article by Don Fernie in *Publications of the Astronomical Society of the Pacific*, 81, pp. 707-731, 1969). It was later improvements to the calibration, the separation of less luminous Type II Cepheids and RR Lyrae variables from classical Cepheids, and the rediscovery of Cepheids in open clusters in the 1950s that ultimately revised the zero-point of the PL relation upwards and led to increases in the estimated distance to M31.

As I gradually lost confidence in the contents of *Discovery*, I realized that it was impossible for me to recommend this book to RASC members or others. It is sad, actually, since controversial discoveries have been and continue to be made in astronomy; for example, Chip Arp's observed coincidences of high-redshift quasars with nearby, perturbed galaxies along nearly identical sight lines, or Gerrit Verschuur's recently found spatial coincidences of nearby hydrogen clouds in the galactic halo with acoustic bubbles identified in the cosmic microwave background radiation. The only controversy worth noting in *Discovery and Classification in Astronomy* rests on how it managed to get such glowing reviews as those on its back cover.

## David G. Turner

*David Turner is Emeritus Professor of Astronomy and Physics at Saint Mary's University and the book review editor of the Journal. He has made several discoveries in astronomy during his career, but none that are mentioned in the book reviewed here.*

*The Royal Astronomical Society of Canada is dedicated to the advancement of astronomy and its related sciences; the Journal espouses the scientific method, and supports dissemination of information, discoveries, and theories based on that well-tested method.*

**A Student's Guide to the Mathematics of Astronomy**, by Daniel Fleisch and Julia Kregenow, pages 197+viii, 15 cm × 23 cm, Cambridge University Press, 2013. Price \$28.99 USD, softcover (ISBN: 978-1-107-61021-7).

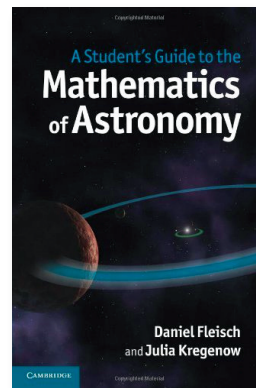

Those of us who have spent much of our careers teaching astronomy to non-science undergraduates know that the initial attraction the subject holds for many people can dissipate with the first appearance of a mathematical equation. In the words of the authors, the sole purpose of *A Student's Guide to the Mathematics of Astronomy* is "to help you understand and apply the mathematics used in college-level astronomy." While the targeted reader is the student taking

an introductory astronomy course at a college or university, it could just as well be the amateur astronomer who has been attracted initially by the visual beauty of the astronomical Universe, enjoys the views through telescopes, but who now wants to delve deeper and acquire an understanding of the relevant physical processes. A deep understanding requires the ability to analyze, and analysis requires mathematics.

The authors begin at... well, at the beginning. The first chapter addresses very basic issues such as unit conversions, the handling of ratios, and scientific notation. The instruction is detailed even to the extent of explicitly striking out units and factors common to the numerator and denominator in an equation. That practice is followed throughout the book. While it may be derided by some instructors as excessive "hand-holding" and insulting to instructor and student alike, the fact is that it is necessary in overcoming the "math phobia" that keeps many people away from the physical sciences. There is sufficient detail given for every topic and for every example that the mathematically averse individual ought to be able to learn solely from the content of the book without need of an instructor.

The remaining five chapters examine five broad areas: (i) Gravity; (ii) Light; (iii) Parallax, Angular Size, and Angular Resolution; (iv) Stars (magnitude system, HR diagram), and (v) Black Holes and Cosmology. The emphasis is always on the mathematics, but the physical explanations are uniformly excellent. For example, the discussion of angular resolution, including the point-spread function and the Airy disk, is superior to what I have seen in any introductory astronomy textbook. It was not the intent of the authors to write a comprehensive astronomy textbook. Hence, they have been very judicious in their selection of astronomical topics to be included.

Each of the six chapters is divided into four to six sections. Within each section there are several exercises to test the



reader's comprehension of the immediately preceding material. At the end of each chapter, there are ten or eleven problems. The solutions to the problems are given in complete, step-by-step detail on the authors' Web site, [www4.wittenberg.edu/sgmoa](http://www4.wittenberg.edu/sgmoa). On that Web site, you will find supplementary material, such as the derivations of some equations and definitions of some mathematical and scientific terms that appear in the body of the text. The Web site also contains video clips featuring the authors speaking in a personal manner. In addition to the authors' on-line offerings, the publisher's Web site at [www.cambridge.org/9781107610217](http://www.cambridge.org/9781107610217) includes samples of pages from the book.

The printed book is mercifully free of typographical, grammatical, and factual errors. On the authors' Web site, a random sampling of two problems from each of the five chapters resulted in discovery of only one error: in the descriptive portion of the full solution for problem 1.10 "1 million" appears rather than the correct "100 billion," but the mathematical solution is correct.

I strongly recommend the book to anyone who finds the mathematics associated with astronomy—or with any other science at the introductory level—a challenge. To better appreciate the content of the book, the level of the mathematics, and the methodology of the authors, I suggest that you go to the two Web sites given above to satisfy yourself that the book will meet your needs.

### Douglas P. Hube

*Doug Hube is a member of the Edmonton Centre RASC and Professor Emeritus, Department of Physics, at the University of Alberta. He served as President of the Society in 1994–96, was a 1982 recipient of the Society's Service Award, and has been Associate Editor (Research) for the Journal for more than a decade.*

**Fundamental Planetary Science: Physics, Chemistry and Habitability**, by Jack J. Lissauer and Imke de Pater, pages 583+viii, 19 cm × 25 cm, Cambridge University Press, 2013. Price \$60 USD, softcover (ISBN: 978-0-521-61855-7).

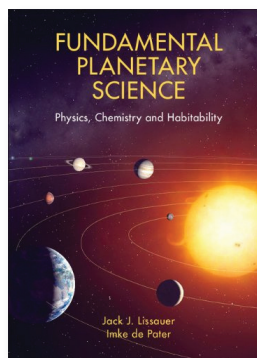

Given the key role played by planetary science in the programs of the principal national space agencies, it is not surprising to see a blossoming of books on the topic. *Fundamental Planetary Science* is a major document, explicitly intended as a university manual at the senior undergraduate and graduate levels. If I were teaching such a course, I would indeed recommend this encyclopedic text to my students,

but with significant reservations. In a review intended for amateur astronomers, however, I must emphasize that the

book is not an easily accessible oracle. Indeed, the text has a certain "Jekyll & Hyde" quality about it.

*Fundamental Planetary Science* comes across as a "third edition" of the authors' book *Planetary Sciences* (2001 and 2010). The 2001 book was focused on concepts and processes. The current book is a strange mix of the same approach with a somewhat re-arranged content, plus added chapters on specific planetary bodies and misplaced intellectual meanderings on life thrown in for good measure. The authors appear uncertain about where they want to take the new text, and make the mistake of trying to be all things to all readers—likely within imposed publishing constraints.

Whereas the 2001 book was perhaps overly quantitative, it was at least linear. The rewrite is now a mix of tough slogging through, for example, the opaquely presented first-year university math that peppers the early chapters on dynamics, physics and astrophysics, solar heating and energy transport, and planetary atmospheres. The bulk of the book presents a mostly prose-based, dogmatic, and, in my opinion, out-dated view of our Solar System. If you are looking for a refresher course on the quantitative details of orbital mechanics and dynamics, tides and tidal heating, thermodynamics, black body radiation, adiabatics, *etc.*, you will find it here. However, chapters focused on the geoscience of planetary surfaces and interiors, the terrestrial planets and the Moon, planetary satellites, minor planets, and comets, left me thirsting for more input from the authors. In part, the latter chapters contain errors in geoscience knowledge; they are so cursory that a lay person will have trouble following the threads—for example, the section on tectonics.

More critically, the authors tend to present only the predominantly accepted geoscience concepts and are either unaware of—or choose to ignore—many of the exciting recent and ongoing debates (some quite lively) regarding our appreciation of how planets (especially our own) and moons in our Solar System work. For example, despite their obvious understanding of the influence of pressure on the physical states of planetary mantles, the authors continue to present the classical mantle plume model throughout the book as though there were no alternative view (there is!). They repeatedly attribute plate tectonics to a mantle convection-driving force, whereas current thinking favours that drive by slab sinking at subduction zones. They make no mention of the plate tectonic analogy identified on Saturn's ice moon Enceladus, while misidentifying features on the Jovian ice moon Europa as resembling mid-ocean ridges. Water in volcanic minerals on the Moon that raised questions regarding the impact origin of our satellite, the debate regarding an ancient northern ocean on Mars and the identification of an oceanic shoreline, challenges to the endogenous origins of coronae and plateaus on Venus—such topics are not even mentioned, let alone critically evaluated. All linear features on rocky planets and ice moons are dutifully ascribed to crustal extension, with no

critical appraisal of the consequences for the global radius of those bodies. Even a brief glance at the gravity-topography-crustal thickness relations for Mars, illustrated in the book, shows that the stated close connection between them, and the consequent simplistic interpretation, requires re-evaluation. The book recounts the impact model for the demise of the dinosaurs as though there were no alternative volcanically related argument. The authors repeatedly refer to “terraforming” Mars, with no explanation of how to protect a renewed atmosphere in the absence of a planetary magnetic field; that is not science. I could go on, but you get the point. In all cases, the authors are uncritically presenting the current dogma. The overall result is a plodding listing of descriptions, and an absence of the excitement that should stem from recent and ongoing scientific debates.

Most disappointing was the chapter on planet formation. Without doubt, it is a comprehensive, though disjointed, summary of the various processes and mechanisms that go into making planets and planetary systems. However, it almost seems intentionally to avoid drawing the threads together to describe—and critically evaluate—the most recent (now a decade old and still evolving) and most exciting model for the formation and evolution of our own Solar System (comprising the “Nice” and the “Grand Tack” phases), the only planetary system for which we have enough observational data to erect such a model (which also has implications for extra-solar systems). Throughout the book there are oblique references to giant-planet migrations and their potential for impact on evolving planetary systems, but we are left wondering what it all means. If the authors wish to reject the model, then they should do so rather than ignoring it.

My take-home message is this: *Fundamental Planetary Science* is a great resource (and a bargain at the price) for those who either have access to excellent mentoring to fill the gaps and critically evaluate its errors, or who have an advanced understanding of planetary science and are looking for an encyclopedic reference work with an emphasis on physics and chemistry. I thoroughly enjoyed reading it, but you may not.

### Simon Hanmer

*Dr. Simon Hanmer is a retired research scientist with 40 years of experience in terrestrial geology, and several decades of amateur interest in astronomy, especially planetary geology. He is an active member of the RASC Ottawa Centre.*

**Astrobiology: A Very Short Introduction**, by David C. Catling, pages 160+xiv, 11 cm × 17 cm, Oxford University Press, 2013. Price \$11.95, softcover (ISBN: 978-0-19-958645-5).

As I write this review, I am teaching a five-lecture continuing-studies course on astrobiology to 40 later-life learners at Ryerson University, in Toronto. I do not require a formal

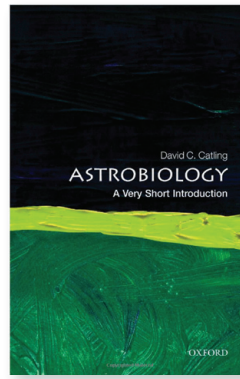

textbook, but I want to provide the class with a short list of books and Web sites to integrate and expand their understanding of the subject. For many years, I taught an undergraduate course in astrobiology at the University of Toronto (under the title “Cosmic Evolution”), and used *Life in the Universe* by Bennett and Shostak as a textbook. It is a superb textbook, but it costs over \$100, so I would not expect students

in my continuing-studies course to buy it, though they might want to use it as a reference. I immediately checked one of my favourite series of books—the *Very Short Introductions* (VSIs) published by Oxford University Press. Lo and behold: in October 2013 they had published *Astrobiology: A Very Short Introduction!*

As of early 2014, there were 377 VSIs covering a vast range of fundamental topics in the arts, humanities, and sciences. They are small-format, typically about 150 pages in length, in black and white, and written by eminent scholars who are also effective writers. I already use *Galileo*, by Stillman Drake, and *History of Astronomy*, by Michael Hoskin, as references for courses, lectures, and the International Year of Astronomy and its follow-ups. Stillman Drake (1910-1993), of the University of Toronto, was one of the greatest of all Galileo scholars. Michael Hoskin, of Cambridge University, has written some of the very best books on the history of astronomy. There is also *Cosmology*, by Peter Coles; *Galaxies*, by John Gribbin; *Planets*, by David Rothery; and *Stars*, by Andrew King. The books currently sell for \$11.95 in my university bookstore, and less as e-books.

David Catling is an astrobiologist at the University of Washington, in Seattle. He is an expert on planetary atmospheres, and has been a principal investigator or co-investigator on several NASA projects, mostly related to Mars. He has taught courses in astrobiology at several levels, and the language and presentation in *Astrobiology: A Very Short Introduction* reflects his experience as a teacher.

The chapters and page counts illustrate the emphasis of the book. It begins with short (13-14 pages) chapters on “What is Astrobiology?” and on the nature and evolution of stars and the origin of stars and planets. There are then three chapters (54 pages—almost half the book) on Earth history and the origin and evolution of life on Earth. Life in the Solar System is dealt with in a longer (28-page) chapter, and exoplanets, including biosignatures and the Search for Extra-Terrestrial Intelligence (SETI), in a short (15-page) one. “Controversies and prospects” (mostly a critique of the Rare-Earth Hypothesis) occupy one final, very short chapter. Exoplanets, by the way, are well covered by my colleague Ray Jayawardhana’s



*Strange New Worlds: The Search for Alien Planets* (Harper Collins, 2011), and there is no shortage of books that deal with SETI and other such interesting but speculative topics. There are 11 black-and-white illustrations in the book, a 2-page reading list, and a good index.

The three core chapters discuss the most important (and problematic) topics in the origin and evolution of life on Earth: the “late heavy bombardment” (as opposed to the initial bombardment during the Hadean Era); the problem of the origin of organic carbon on the primitive Earth; the “faint, young Sun paradox” (which seems to require a strong greenhouse effect in early Earth history); the “great oxidation” and other steps by which the Earth’s atmosphere achieved its present oxygen concentration; the “Cambrian explosion” 540 million years ago, in which the diversity of species increased dramatically; “snowball Earth” episodes in which Earth totally (or more likely, partially) froze over; the discovery of terrestrial “extremophiles” that can thrive in extreme environments; and recent advances in using molecular biology techniques to study the origin and evolution of life on Earth.

As with most of the VSIs, *Astrobiology* comes with a short, freely downloadable study guide of high-level questions for thought and discussion. They would be excellent questions for a final exam (if there were a final exam) to test whether students had understood the material and could express their understanding. The questions would also be excellent fodder for a book club. They challenge the reader to think about questions such as: How broad should the definition of life be? What role (if any) did chance play in allowing Earth to be habitable? How will technology affect the future evolution of life on Earth? Could Europa’s subsurface ocean have no life at all? Is “Fermi’s paradox” (that there should be many advanced civilizations in our galaxy, but we have not encountered them) an unjustified extrapolation of our own history and beliefs? Is it dangerous to send messages to extraterrestrial life (ETL)? And much more.

The origin and development of life on Earth is clearly the emphasis in *Astrobiology: A Very Short Introduction*, and that is welcome and makes the book a useful addition to the astrobiology library. The mechanism and probability of the origin of life is clearly the “missing link” in the whole question of life in the Universe—that is apparent from Drake’s Equation. Some progress is being made by life scientists such as Nobel laureate Jack Szostak, but the progress is not as rapid as with our understanding of extrasolar planets. It would be nice to think that we will actually discover ETL in our lifetime. Or at least make significant progress.

### John R. Percy

*John Percy is Professor Emeritus, Astronomy and Astrophysics, and Science Education, University of Toronto, and Honorary President of the RASC. \**

## Society News



by James Edgar, Regina Centre  
(james@jamesedgar.ca)

Since we re-wrote our By-Law #1 and changed our governance model last year, the first-ever full election is underway.

We already have applications from prospective candidates for the nine positions available on the Board of Directors in this “one-off” election. Hereafter, there will be an annual election for three positions on the Board, ensuring an opportunity for interested members to become involved in running the Society. A link to the call for nominations is on the [www.rasc.ca](http://www.rasc.ca) home page. Once the Board of Directors is elected by the membership, those nine Directors will elect the Executive from within their number.

Speaking of the home page, there has been some remodelling lately, thanks to Melissa Mascarin at the Society Office. Have a look around to see what’s changed at [www.rasc.ca](http://www.rasc.ca).

And, speaking of Melissa Mascarin, she gave her notice to leave our employment and we are actively looking for a replacement Marketing Manager at the Society Office. Melissa was a hard-working and knowledgeable person and a valuable asset in the office. We wish her well in her future endeavours. \*

## Solar Eclipses Crossword Answers

by Naomi Pasachoff

S	A	C	O		T	E	T	H		B	R	O	K	E		
E	N	O	L		A	L	A	I		R	O	U	E	S		
E	N	U	S		L	A	B	S		I	A	T	R	O		
S	U	P	E	R	C	L	U	S	T	E	R	S				
A	L	O	N	E				E	H	F		P	O	T		
W	I	N		N	E	R	U	D	A		I	O	N	E		
				R	E	M	U	S		T	A	L	K	E	D	
				E	D	W	I	N	H	U	B	B	L	E		
A	T	L	A	S	T			E	R	O	S	E				
P	E	A	S		A	R	R	O	Y	O		B	I	R		
T	A	P		T	I	E				R	O	O	N	E		
				S	P	I	R	A	L	N	E	B	U	L	A	E
C	R	I	E	D				L	O	O	N		T	E	S	L
H	A	N	T	A				M	O	L	D		E	R	I	E
A	N	G	E	L				S	K	I	S		R	O	A	D

# Astrocryptic

by Curt Nason

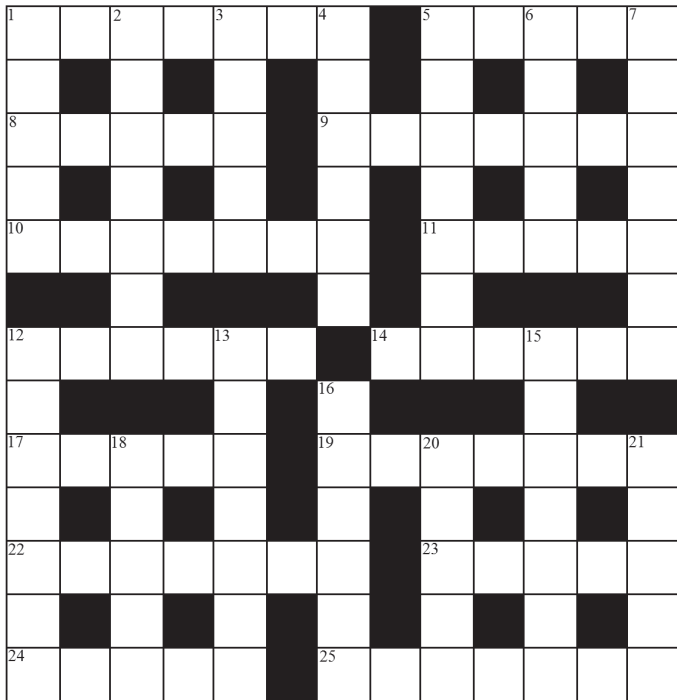

## ACROSS

1. Solar System body found in HG Wells? (7)
5. Sol emits little energy back to the planet (5)
8. Henden previews Rigel-type star below Orion (5)
9. Southern constellation seen in a Telrad (7)
10. Emit from the spaceman a terrible scream (7)
11. Yankee Boyer lost his lunch in the whale (5)
12. Alternative name the Spanish gave to a meteorite component (6)
14. Shadow caster times Moon rotation between end of morning and start of noon (6)
17. Manufacture a pose for the fabulous asteroid (5)
19. Have a binocular view of a hot, stellar association in parts of Serpens and Vela (7)
22. I run into Henry Draper before encountering round asteroid (7)
23. Marx's illustrated woman has family beyond Mars (5)
24. Close binary in Ophiuchus shows unusual bias toward K type (5)
25. It receives radio waves from NGC 4039 (7)

## DOWN

1. Telescopes made around Easter by them (5)
2. Feature of Saturn racing around after Rhea (4,3)
3. Greek character backing supporter in the eclipse path (5)
4. Unusual eerie sky that is dispersed over Midwest observatory (6)
5. Vacation ruined when nothing is lost at the observatory in Castel Gandolfo (7)
6. First OH editor tossed and turned when Galle observed (5)
7. Cowboy topper was an astronomer. True? (7)
12. China's first observatory disassembled west of Hellas basin (7)
13. Handbook contributor to speak about nothing after eclipse begins (7)
15. Late orbital computer had wild dreams before November 1st (7)
16. Imported beer seen around the Moon on occasion (6)
18. Cancel the mission to Crux in spring break (5)
20. Resolve the binary from a coastal sandbar around Labrador (5)
21. The French return half of Arabia to go around Jupiter (5)

## Answers to April's Astrocryptic

### ACROSS

- 1 DWARF PLANET (example, def); 9 ALIEN (a lien); 10 UMBRIEL (anag + i); 11 SAPPORO (2 def); 12 YEARS (2 def); 13 GEGENSCHNITT (anag); 18 RADON (Rodan -> Radon); 20 RED SPOT (r+anag); 22 STAR MAP (anag); 23 LEICA (homonym); 24 SOLAR STORMS (anag)

### DOWN

- 2 WHIPPLE (whi(pp)le); 3 RINGO (anag); 4 PLUTO (2 def); 5 ABBEY (2 def); 6 ERIDANI (anag); 7 MARSH (hid); 8 CLAST (hid); 14 EUNOMIA (anag); 15 HIDALGO (hid + algo); 16 CROSS (2 def); 17 ATLAS (2 def); 19 DRACO (abb + a + abb); 20 RUPES (anag); 21 PRISM (p (sir rev.)m)

# It's Not All Sirius

by Ted Dunphy

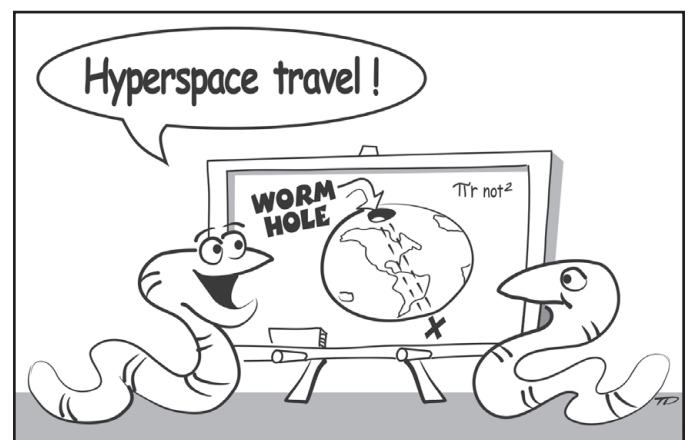

RASC members receiving this *Journal* in electronic format are hereby granted permission to make a single paper copy for their personal use.



# THE ROYAL ASTRONOMICAL SOCIETY OF CANADA

## Board of Directors and appointed officers for 2014 | Conseil d'administration et membres attirés pour 2014

### Honorary President

John R. Percy, Ph.D., Toronto

### President

Glenn Hawley, B.Sc., B.Ed., Calgary

### 1st Vice-President

Colin Haig, B.Sc., M.Sc., Hamilton

### 2nd Vice-President

Chris Gainor, B.A., M.Sc., Ph.D., Victoria

### Secretary

James Edgar, Regina

### Treasurer

Denis Grey, B. Math., M.B.A., Toronto

### Director

Paul Gray, Halifax

### Director

Craig Levine, London

### Director

Paul Schumacher, D.D.S., M.T.S., Victoria

### Past President

Mary Lou Whitehorne, Halifax

### Executive Director

Deborah Thompson, CAE, Society Office

### Editors

#### Journal

Jay Anderson, B.Sc., MNRM, Winnipeg

#### Observer's Handbook

David M.F. Chapman, M.Sc., Halifax

#### Beginner's Observing Guide

Brenda Shaw, Toronto

#### eBulletin

Dave Garner, B.Sc., M.o.A., Kitchener-Waterloo

#### Observer's Calendar

Paul Gray, Halifax

## Great Images

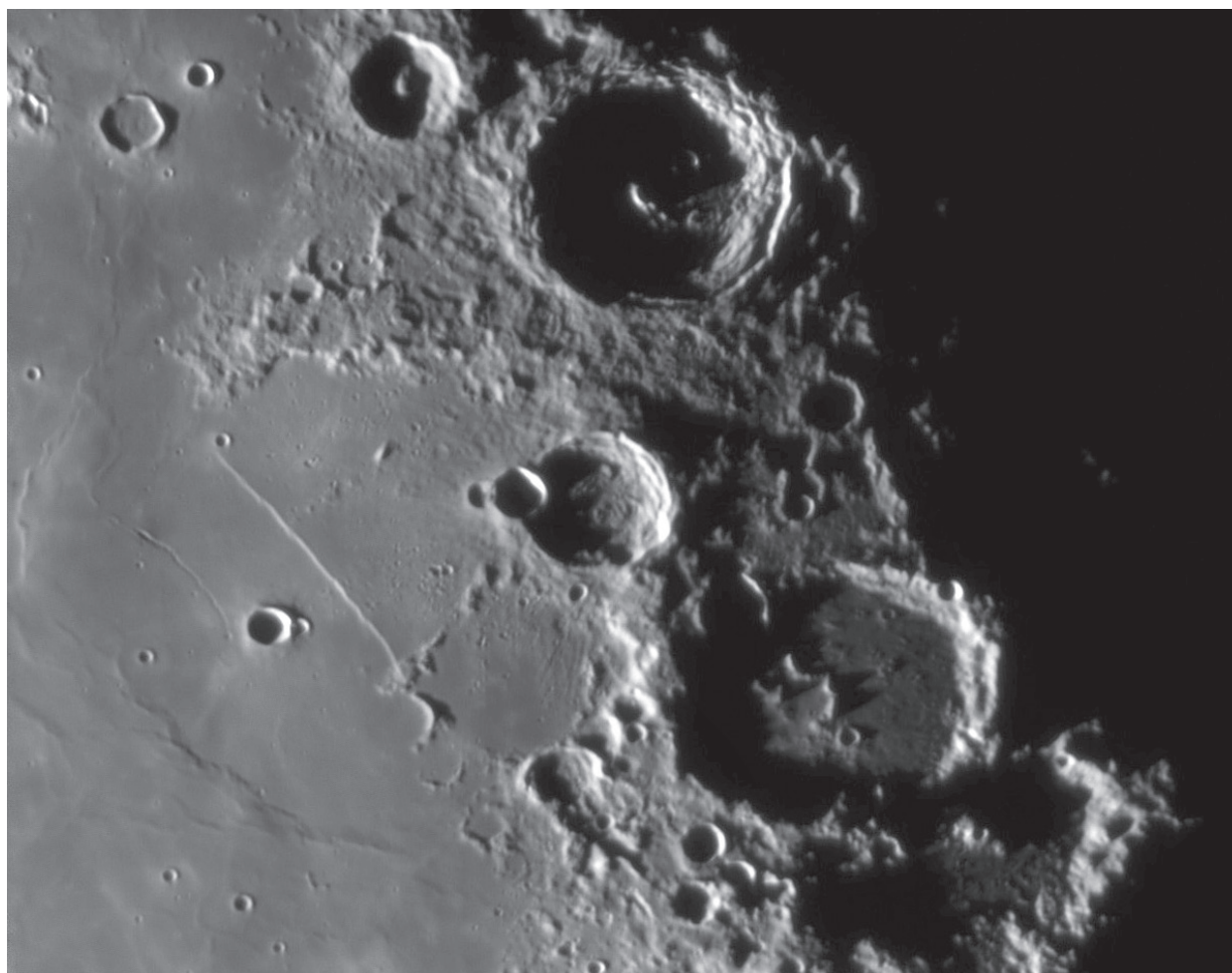

*Steve Mastellotto of the Windsor Centre captured one of the Moon's most popular and magnificent scenes in this image of the Straight Wall (Rupes Recta) in the southeast corner of Mare Nubium. The escarpment has a length of 120 km, a width of 2-3 km, and a height that ranges from 240 to 300 m. Under low-light conditions, it appears to be a sharp discontinuity, but its true slope is rather gentle. The 125 frames from Steve's video sequence of the scene were captured last September using a ZWO ASI 120-mm video camera on a C14 telescope.*



# Journal

## Great Images

*Ron Brecher owns the back cover with this captivating image of Messier 106, a spiral galaxy in Canes Venatici that lies about 24 Mly from his telescope. M106 is a Seyfert galaxy, so-named because of an active black hole at its core. The galaxy below M106 is NGC 4248. Ron used an SBIG STL-11000M camera on a 10" ASA astrograph. Exposure was 8×5 m in each of R, G, and B; 84×10 m in L; and 6×20 m in H $\alpha$ .*